



**DURATHON<sup>2</sup>**

**H10H4-M19**

**USER GUIDE**

Version:1.0

**HDMI** ISO-9001 ISO-14001 **CE** **FC** 

# Preface

## Copyright

This publication, including all photographs, illustrations and software, is protected under international copyright laws, with all rights reserved. Neither this manual, nor any of the material contained herein, may be reproduced without written consent of the author.

Version 1.0

## Disclaimer

The information in this document is subject to change without notice. The manufacturer makes no representations or warranties with respect to the contents hereof and specifically disclaims any implied warranties of merchantability or fitness for any particular purpose. The manufacturer reserves the right to revise this publication and to make changes from time to time in the content hereof without obligation of the manufacturer to notify any person of such revision or changes.

## Trademark Recognition

Windows® 10/8.1/7 are registered trademarks of Microsoft Corp.

Other product names used in this manual are the properties of their respective owners and are acknowledged.

## Federal Communications Commission (FCC)

This equipment has been tested and found to comply with the limits for a Class B digital device, pursuant to Part 15 of the FCC Rules. These limits are designed to provide reasonable protection against harmful interference in a residential installation. This equipment generates, uses, and can radiate radio frequency energy and, if not installed and used in accordance with the instructions, may cause harmful interference to radio communications. However, there is no guarantee that interference will not occur in a particular installation. If this equipment does cause harmful interference to radio or television reception, which can be determined by turning the equipment off and on, the user is encouraged to try to correct the interference by one or more of the following measures:

- Reorient or relocate the receiving antenna
- Increase the separation between the equipment and the receiver
- Connect the equipment onto an outlet on a circuit different from that to which the receiver is connected
- Consult the dealer or an experienced radio/TV technician for help

Shielded interconnect cables and a shielded AC power cable must be employed with this equipment to ensure compliance with the pertinent RF emission limits governing this device. Changes or modifications not expressly approved by the system's manufacturer could void the user's authority to operate the equipment.

## Declaration of Conformity

This device complies with part 15 of the FCC rules. Operation is subject to the following conditions:

- This device may not cause harmful interference, and
- This device must accept any interference received, including interference that may cause undesired operation.

This device is in conformity with the following EC/EMC directives:

- EN 55032** Electromagnetic compatibility of multimedia equipment - Emission requirements
- EN 61000-3-2** Electromagnetic Compatibility(EMC)  
Part 3-2: Limits-Limits for harmonic current emissions (equipment input current  $\leq 16A$  per phase)
- EN 61000-3-3** Electromagnetic Compatibility(EMC)  
Part 3-3: Limits-Limitation of voltage changes, voltage fluctuations and flicker in public low-voltage supply systems, for equipment with rated current  $\leq 16A$  per phase and not subject to conditional connection
- EN 55024** Information technology equipment-Immunity characteristics-Limits and methods of measurement
- EN 60950** Safety for information technology equipment including electrical business equipment
- CE marking** 





## Canadian Department of Communications

This class B digital apparatus meets all requirements of the Canadian Interference-causing Equipment Regulations.

Cet appareil numérique de la classe B respecte toutes les exigences du Règlement sur le matériel brouilleur du Canada.

## About the Manual

The manual consists of the following:

- Chapter 1**  
**Introducing the Motherboard** Describes features of the  page 1 motherboard.
- Chapter 2**  
**Installing the Motherboard** Describes installation of  page 7 motherboard components.
- Chapter 3**  
**Using BIOS** Provides information on  page 25 using the BIOS Setup Utility.
- Chapter 4**  
**Using the Motherboard Software** Describes the motherboard  page 61 software.
- Chapter 5**  
**Trouble Shooting** Provides basic trouble  page 65 shooting tips.

# TABLE OF CONTENTS

---

---

<b>Preface</b>	<b>i</b>
<b>Chapter 1</b>	<b>1</b>
<b>Introducing the Motherboard</b>	<b>1</b>
Introduction.....	1
Package Contents.....	1
Specifications.....	2
Motherboard Components.....	4
I/O Ports.....	6
<b>Chapter 2</b>	<b>7</b>
<b>Installing the Motherboard</b>	<b>7</b>
Safety Precautions.....	7
Installing the Motherboard in a Chassis.....	7
Checking Jumper Settings.....	8
Installing Hardware.....	9
<i>Installing the Processor.....</i>	<i>9</i>
<i>Installing the CPU Cooler.....</i>	<i>11</i>
<i>Installing Memory Modules.....</i>	<i>12</i>
<i>Installing Add-on Cards.....</i>	<i>13</i>
<i>Connecting Optional Devices.....</i>	<i>15</i>
<i>Installing a SATA Hard Drive.....</i>	<i>20</i>
Connecting Case Components.....	21
<i>Front Panel Header.....</i>	<i>23</i>
<b>Chapter 3</b>	<b>25</b>
<b>Using BIOS</b>	<b>25</b>
About the Setup Utility.....	25
<i>The Standard Configuration.....</i>	<i>25</i>
<i>Entering the Setup Utility.....</i>	<i>25</i>
<i>Resetting the Default CMOS Values.....</i>	<i>26</i>
Using BIOS.....	26
<i>BIOS Navigation Keys.....</i>	<i>27</i>
<i>Main Menu.....</i>	<i>28</i>
<i>Advanced Menu.....</i>	<i>29</i>
<i>Chipset Menu.....</i>	<i>42</i>
<i>Tweak Menu.....</i>	<i>49</i>
<i>Security Menu.....</i>	<i>55</i>
<i>Boot Menu.....</i>	<i>56</i>
<i>Exit Menu.....</i>	<i>58</i>

Updating the BIOS.....	59
<b>Chapter 4</b>	<b>61</b>
<b>Using the Motherboard Software</b>	<b>61</b>
Auto-installing under Windows 10/8.1/7.....	61
<i>Running Setup</i> .....	61
Manual Installation.....	63
ECS Utility Software (Intelligent EZ Utility).....	63
<b>Chapter 5</b>	<b>65</b>
<b>Trouble Shooting</b>	<b>65</b>
Start up problems during assembly.....	65
Start up problems after prolong use.....	66
Maintenance and care tips.....	66
Basic Troubleshooting Flowchart.....	67

# Chapter 1

## ***Introducing the Motherboard***

---

### **Introduction**

Thank you for choosing the **H110H4-M19** motherboard. This motherboard is a high performance, enhanced function motherboard designed to support the LGA1151 socket for Intel® Skylake processor.

This motherboard is based on **Intel® H110 Express Chipset** for best desktop platform solution. It supports up to **32 GB** of system memory with dual channel DDR4 **2133** MHz. High resolution graphics via one PCIe x16 Gen3 slot.

It integrates USB 2.0 and USB 3.0 interface, supporting up to five USB 2.0 ports (two USB 2.0 ports at the rear panel, one 10-pin USB 2.0 header supports additional two USB 2.0 ports and one 5-pin USB 2.0 header supports additional one USB 2.0 port) and four USB 3.0 ports (two USB 3.0 ports at the rear panel and one USB 3.0 header supports additional two USB 3.0 ports) .

The motherboard is equipped with advanced full set of I/O ports in the rear panel, including PS/2 keyboard and mouse combo connector, two USB 2.0 ports, one RJ45 LAN connector, two USB 3.0 ports, one VGA port, one HDMI port, and audio jacks for line-in, line-out and microphone.

In addition, this motherboard supports four SATA 6Gb/s connectors for expansion.

### **Package Contents**

Your motherboard package ships with the following items:

- H110H4-M19 Motherboard
- User Manual
- DVD
- I/O Shield
- 2 SATA 6Gb/s cable



*The package contents above are for reference only, please take the actual package items as standard.*

## Specifications

<b>CPU</b>	<ul style="list-style-type: none"> <li>• LGA1151 socket for Intel® Skylake processor</li> <li>• Supports CPU up to 65W</li> </ul> <p><i>Note: Please go to ECS website for the latest CPU support list.</i></p>
<b>Chipset</b>	<ul style="list-style-type: none"> <li>• Intel® H110 Chipset</li> </ul>
<b>Memory</b>	<ul style="list-style-type: none"> <li>• Dual-channel DDR4 memory architecture</li> <li>• 2 x 288-pin DDR4 LONG DIMM sockets support up to 32 GB</li> <li>• Supports DDR4 2133 MHz DDR4 SDRAM</li> </ul> <p><i>Note: Please go to ECS website for the latest Memory support list.</i></p>
<b>Expansion Slots</b>	<ul style="list-style-type: none"> <li>• 1 x PCI Express x16 Gen3 slot</li> <li>• 1 x NGFF M.2 (2230) slot</li> </ul>
<b>Storage</b>	<ul style="list-style-type: none"> <li>• Supported by Intel® H110 Express Chipset</li> <li>- 4 x Serial ATA 6Gb/s devices</li> </ul>
<b>Audio</b>	<ul style="list-style-type: none"> <li>• Realtek ALC662-VD0-GR 6-CH High Definition audio CODEC</li> <li>- Compliant with HD audio specification</li> </ul>
<b>LAN</b>	<ul style="list-style-type: none"> <li>• Realtek RTL8111H Gigabit Lan</li> </ul>
<b>Rear Panel I/O</b>	<ul style="list-style-type: none"> <li>• 1 x PS/2 mouse &amp; PS/2 keyboard connector</li> <li>• 1 x HDMI port</li> <li>• 1 x D-sub port (VGA port)</li> <li>• 2 x USB 2.0 ports</li> <li>• 2 x USB 3.0 ports</li> <li>• 1 x RJ45 LAN connector</li> <li>• 1 x Audio 6-ch jacks (line-in, line-out, microphone)</li> </ul>
<b>Internal I/O Connectors &amp; Headers</b>	<ul style="list-style-type: none"> <li>• 1 x 24-pin ATX Power Supply connector</li> <li>• 1 x 4-pin ATX 12V Power connector</li> <li>• 1 x 4-pin CPU_FAN connector</li> <li>• 1 x 4-pin SYS_FAN connector</li> <li>• 1 x USB 3.0 header supports additional two USB 3.0 ports</li> <li>• 1 x USB 2.0 header supports additional two USB 2.0 ports</li> <li>• 1 x 5-pin USB 2.0 header supports additional one USB 2.0 port</li> <li>• 4 x SATA 6Gb/s connectors</li> <li>• 1 x Front Panel audio header</li> <li>• 1 x Front Panel switch/LED header</li> <li>• 1 x COM header</li> <li>• 1 x Clear CMOS jumper</li> <li>• 1 x Buzzer header</li> <li>• 1 x Case open header</li> <li>• 1 x Battery connector</li> </ul>

<b>System BIOS</b>	<ul style="list-style-type: none"><li>• AMI BIOS with 64Mb SPI Flash ROM</li><li>• Supports Plug and Play, STR (S3)/ STD (S4), Hardware Monitor</li><li>• Audio, LAN, can be disabled in BIOS</li><li>• F7 hot key for boot up devices option</li><li>• Supports ACPI &amp; DMI</li><li>• Supports PgUp clear CMOS Hotkey (PS2 KB Model only)</li><li>• Add the function of copying BIOS parameters to USB flash drive</li></ul>
<b>AP Support</b>	<ul style="list-style-type: none"><li>• Supports eBLU*/eDLU/eSF*</li></ul> <p><i>Note: *Microsoft .NET Framework 3.5 is required.</i></p>
<b>Form Factor</b>	<ul style="list-style-type: none"><li>• Micro ATX Size, 190mm x 170mm</li></ul>



# Motherboard Components

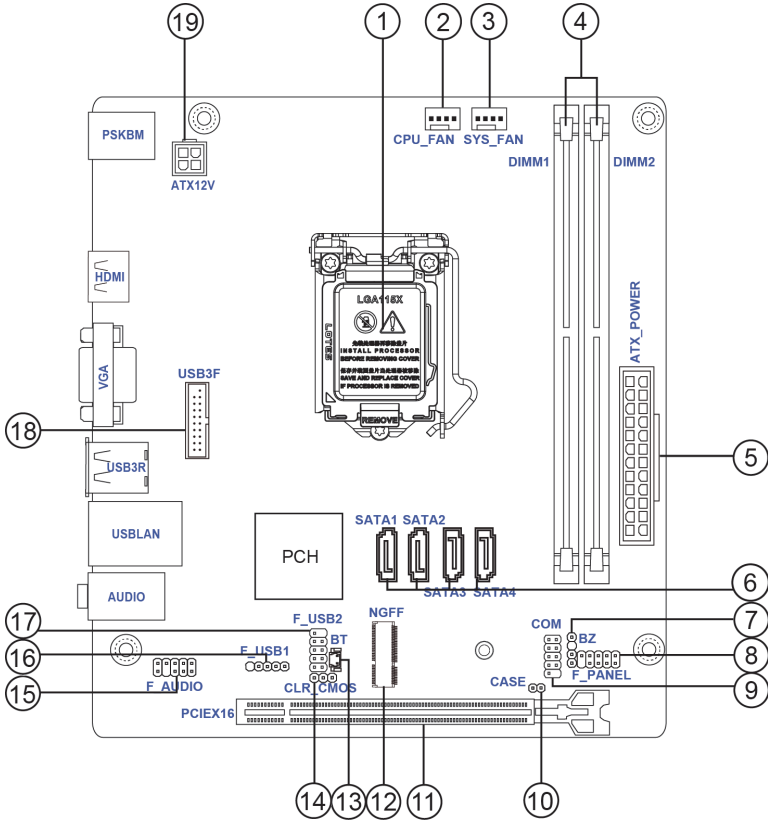

**Table of Motherboard Components**

<b>LABEL</b>	<b>COMPONENTS</b>
1. CPU Socket	LGA1151 socket for Intel® Skylake processor
2. CPU_FAN	4-pin CPU cooling fan connector
3. SYS_FAN	4-pin system cooling fan connector
4. DIMM1~2	288-pin DDR4 Module slots
5. ATX_POWER	Standard 24-pin ATX power connector
6. SATA1~4	Serial ATA 6Gb/s connectors
7. BZ	Buzzer header
8. F_PANEL	Front panel switch/LED header
9. COM	Onboard serial port header
10. CASE	CASE open header
11. PCIEX16	PCI Express x16 slot Gen3 for graphics interface
12. NGFF	M.2 slot for WiFi/BT
13. BT	Battery connector
14. CLR_CMOS	Clear CMOS jumper
15. F_AUDIO	Front panel audio header
16. F_USB1	5-pin Front panel USB 2.0 header
17. F_USB2	Front panel USB 2.0 header
18. USB3F	Front panel USB 3.0 header
19. ATX_12V	4-pin +12V power connector

## I/O Ports

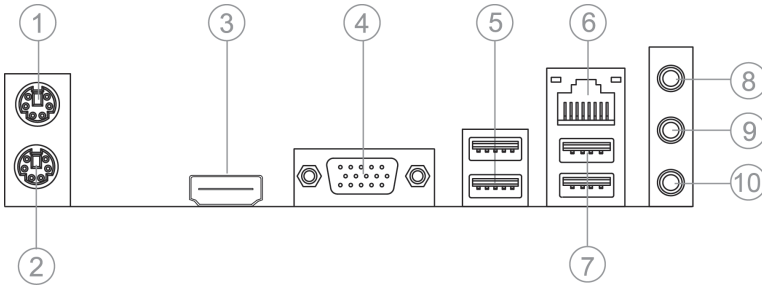
**1. PS/2 Mouse** (green)

Use the upper PS/2 port to connect the PS/2 Mouse.

**2. PS/2 Keyboard** (purple)

Use the upper PS/2 port to connect the PS/2 Keyboard.

**3. HDMI Port**

You can connect the display device to the HDMI port.

**4. VGA Port**

Connect your monitor to the VGA port.

**5. USB 3.0 Ports**

Use the USB 3.0 ports to connect USB 3.0 devices.

**6. LAN Port**

Connect an RJ-45 jack to the LAN port to connect your computer to the Network.

LAN LED	Status	Description
Activity LED	OFF	No data
	Orange blinking	Active
Link LED	OFF	No link
	Green	Link

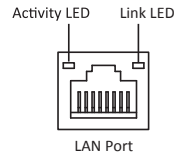
**7. USB 2.0 Ports**

Use the USB 2.0 ports to connect USB 2.0 devices.

**8. Line-in** (blue)

It can be connected to an external CD/DVD player, Tape player or other audio devices for audio input.

**9. Line-out** (lime)

It is used to connect to speakers or headphones.

**10. Microphone** (pink)

It is used to connect to a microphone.

## Chapter 2

### Installing the Motherboard

#### 2-1. Safety Precautions

Follow these safety precautions when installing the motherboard:

- Wear a grounding strap attached to a grounded device to avoid damage from static electricity.
- Discharge static electricity by touching the metal case of a safely grounded object before working on the motherboard.
- Leave components in the static-proof bags.
- Always remove the AC power by unplugging the power cord from the power outlet before installing or removing the motherboard or other hardware components.

#### 2-2. Installing the motherboard in a Chassis

This motherboard carries a Mini ITX form factor of 190 x 170 mm. Choose a chassis that accommodates this form factor. Make sure that the I/O template in the chassis matches the I/O ports installed on the rear edge of the motherboard. Most system chassis have mounting brackets installed in the chassis, which corresponds to the holes in the motherboard. Place the motherboard over the mounting brackets and secure the motherboard onto the mounting brackets with screws.

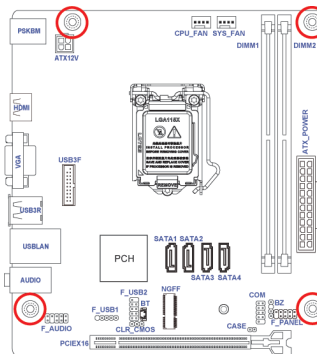

*Do not over-tighten the screws as this can stress the motherboard.*

## 2-3. Checking Jumper Settings

The following illustration shows the location of the motherboard jumpers. Pin 1 is labeled.

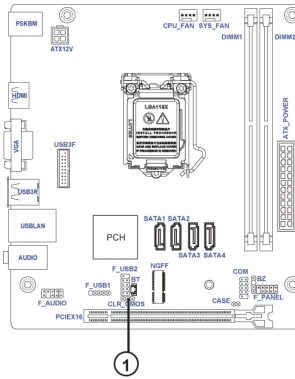

### 1. CLR\_CMOS: Clear CMOS Jumper

Connect a serial port extension bracket to this header to add a serial port to your system.

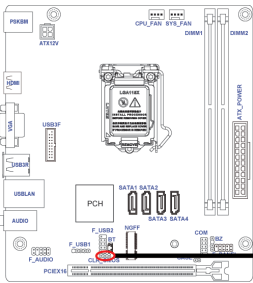

### CLR\_CMOS

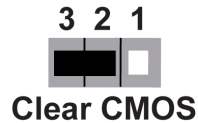
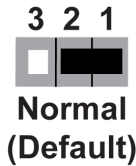

To avoid the system instability after clearing CMOS, we recommend users to enter the main BIOS setting page to “Load Default Settings” and then “Save and Exit Setup”.

## 2-4. Installing Hardware

### 2-4-1. Installing the Processor

- This motherboard has an LGA1151 socket.
- When choosing a processor, consider the performance requirements of the system. Performance is based on the processor design, the clock speed and system bus frequency of the processor, and the quantity of internal cache memory and external cache memory.
- You may be able to change the settings in the system Setup Utility. We strongly recommend you do not over-clock processor or other components to run faster than their rated speed.
- The following illustration shows CPU installation components.

A. Press the hook of lever down with your thumb and pull it to the right side to release it from retention tab.



B. Lift the tail of the load lever and rotate the load plate to fully open position.

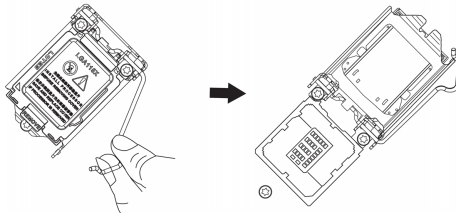

C. Grasp the edge of the package substrate. Make sure pin 1 indicator is on your bottom-left side. Aim at the socket and place the package carefully into the socket by purely vertical motion.

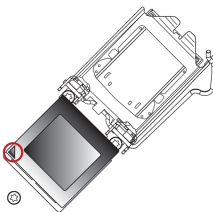

D. Rotate the load plate onto the package IHS (Intergraded Heat Spreader). Engage the load lever while pressing down lightly onto the load plate. Secure the load lever with the hook under retention tab. Then the cover will flick automatically.

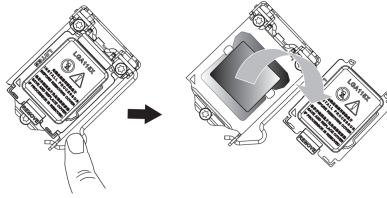

*Please save and replace the cover onto the CPU socket if processor is removed.*

### 2-4-2. Installing the CPU Cooler

- Install the cooling fan in a well-lit work area so that you can clearly see the motherboard and processor socket.
- Avoid using cooling fans with sharp edges in case the fan casing and the clips cause serious damage to the motherboard or its components.
- To achieve better airflow rates and heat dissipation, we suggest that you use a high quality fan with 3800 rpm at least. CPU fan and heat sink installation procedures may vary with the type of CPU fan/heatsink supplied. The form and size of fan/heatsink may also vary.
- DO NOT remove the CPU cap from the socket before installing a CPU.
- Return Material Authorization (RMA) requests will be accepted only if the motherboard comes with the cap on the LGA1151 socket.
- The following illustration shows how to install CPU fan.

A. Apply some thermal grease onto the contacted area between the heatsink and the CPU, and make it to be a thin layer.

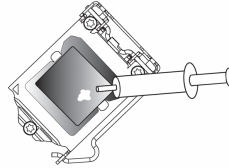

B. Fasten the cooling fan supporting base onto the CPU socket on the motherboard. And make sure the CPU fan is plugged to the CPU fan connector.

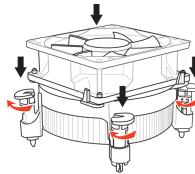

C. Connect the CPU cooler power connector to the CPU\_FAN connector.

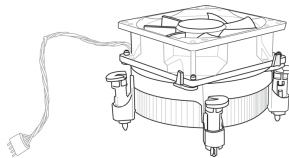



### 2-4-3. Installing Memory Modules

- This motherboard accommodates two memory modules. It can support two 288-pin DDR4 2133 MHz.
- Do not remove any memory module from its antistatic packaging until you are ready to install it on the motherboard. Handle the modules only by their edges. Do not touch the components or metal parts. Always wear a grounding strap when you handle the modules.
- You must install at least one module in any of the two slots. Total memory capacity is 32 GB.
- Refer to the following to install the memory modules.

A. Push the latches on each side of the DIMM slot down.

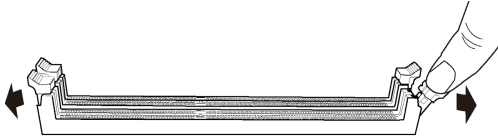

B. Install the DIMM module into the slot and press it firmly down until it seats correctly. Check that the cutouts on the DIMM module edge connector match the notches in the DIMM slot.

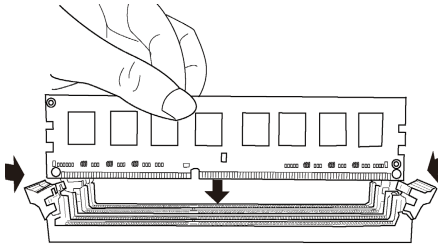

C. The slot latches are levered upwards and latch on to the edges of the DIMM.

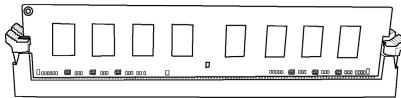

## 2-4-4. Installing Add-on Cards

The slots on this motherboard are designed to hold expansion cards and connect them to the system bus. Expansion slots are a means of adding or enhancing the motherboard's features and capabilities. With these efficient facilities, you can increase the motherboard's capabilities by adding hardware that performs tasks that are not part of the basic system.

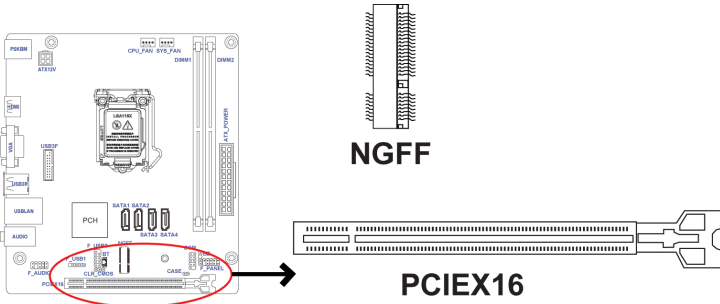

### PCIEX16 Slot

The PCI Express x16 slot is used to install an external PCI Express graphics card that is fully compliant to the PCI Express Base Specification revision 3.0.

### NGFF Slot

This is M.2 slot for 2230 WiFi/BT card. It will provide high transfer performance than original Mini PCIe interface.



*Before installing an add-on card, check the documentation for the card carefully. If the card is not Plug and Play, you may have to manually configure the card before installation.*

Follow these instructions to install an add-on card:

- 1 Remove a blanking plate from the system case corresponding to the slot you are going to use.
- 2 Install the edge connector of the add-on card into the expansion slot. Ensure that the edge connector is correctly seated in the slot.
- 3 Secure the metal bracket of the card to the system case with a screw.



*For some add-on cards, for example graphics adapters and network adapters, you have to install drivers and software before you can begin using the add-on card.*

Please refer the following illustrations to install the add-on card:

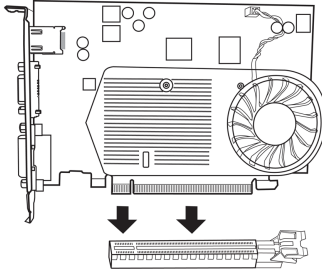

*Install the VGA Card in the PCIE X16 slot*

Please refer the following steps to install the M.2 WiFi/BT card:

- 1 Insert the M.2 WiFi/BT card into NGFF slot in the fool-proof way.

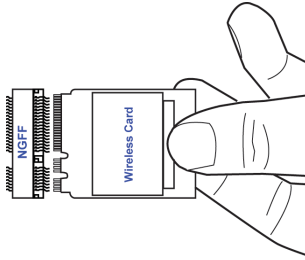

- 2 Lock the screw as the following picture shows to make sure the M.2 WiFi/BT card is installed in place.

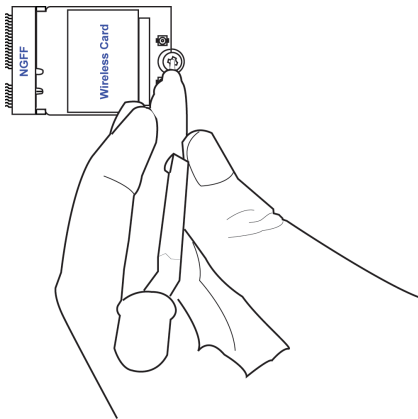

### 2-4-5. Connecting Optional Devices

Refer to the following for information on connecting the motherboard's optional devices:

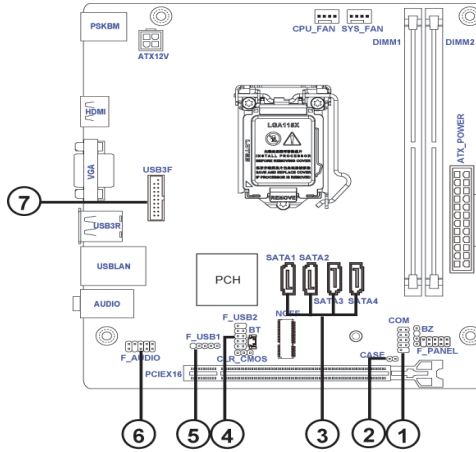

No.	Components	No.	Components
1	COM	5	F_USB1
2	CASE	6	F_AUDIO
3	SATA1~4	7	USB3F
4	F_USB2	~	~

#### 1. COM: Onboard Serial Port Header

Connect serial port extension brackets to this header to add serial port to your system.

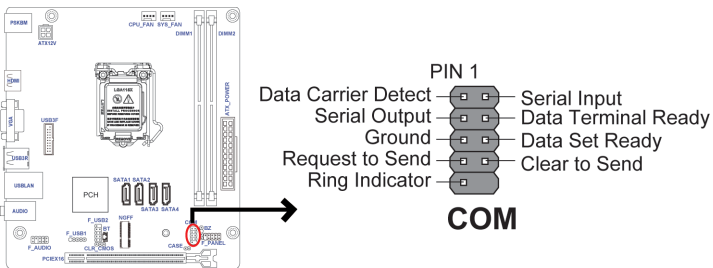

## 2. CASE: Chassis Intrusion Detect Header

This detects if the chassis cover has been removed. This function needs a chassis equipped with intrusion detection switch and needs to be enabled in BIOS.

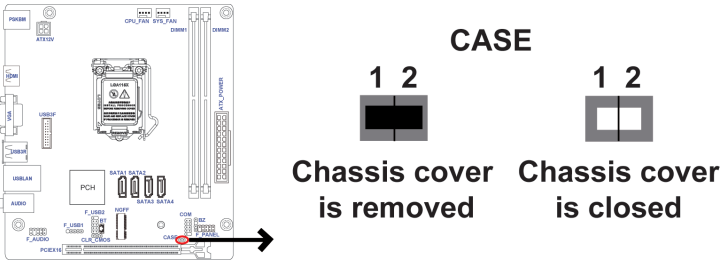

## 3. SATA1~4: Serial ATA Connectors

SATA1~4 connectors are used to support the Serial ATA 6Gb/s device, simpler disk drive cabling and easier PC assembly. It eliminates limitations of the current Parallel ATA interface. But maintains register compatibility and software compatibility with Parallel ATA.

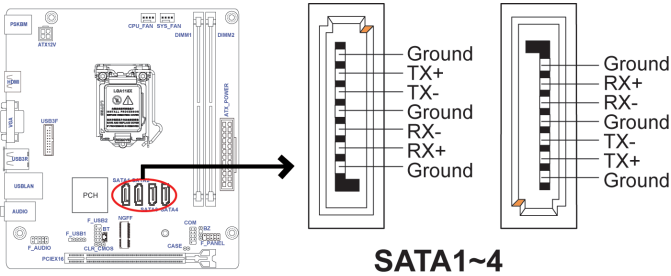

#### 4. F\_USB2: 2\*5-pin Front Panel USB 2.0 header

The motherboard has one USB 2.0 header supporting two USB 2.0 ports. Additionally, some computer cases have USB ports at the front of the case. If you have this kind of case, use auxiliary USB connector to connect the front-mounted ports to the motherboard.

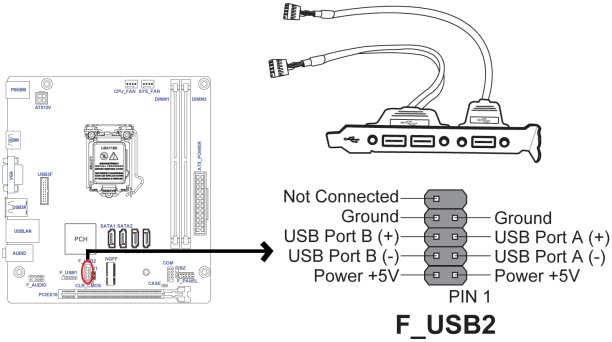

#### 5. F\_USB1: 1\*5-pin Front Panel USB 2.0 header

The motherboard has one 5-pin USB 2.0 header supporting one USB 2.0 ports.

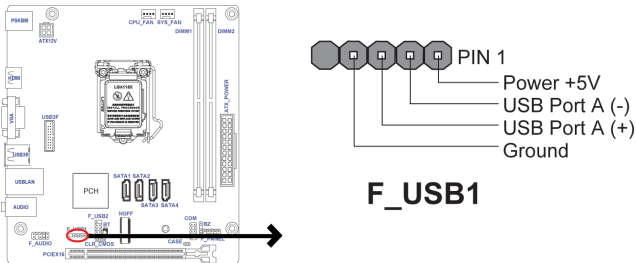

### 6. F\_AUDIO: Front Panel Audio Header

The front panel audio header allows the user to install auxiliary front-oriented microphone and line-out ports for easier access. This header supports HD audio by default. If you want connect an AC' 97 front panel audio to HD onboard headers, please set as below picture.

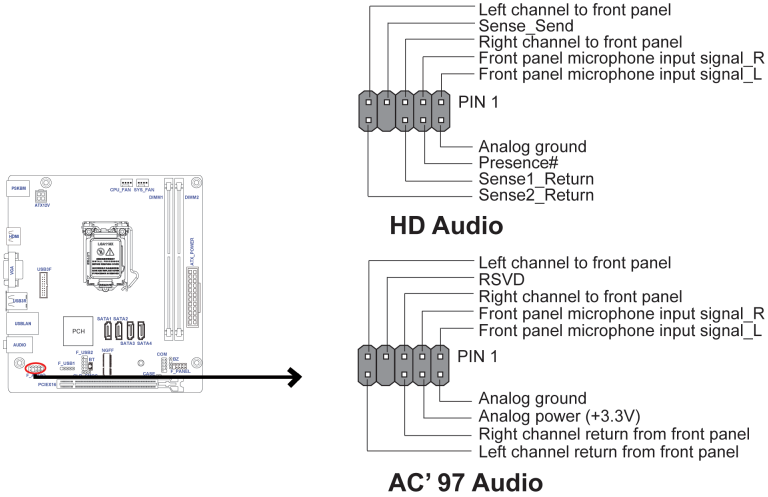

**AC' 97 Audio Configuration:** To enable the front panel audio connector to support AC97 Audio mode.

If you use AC' 97 Front Panel, please tick off the option of “Disabled Front Panel Detect ”. If you use HD Audio Front Panel, please don’ t tick off “Disabled Front Panel Detect ”.

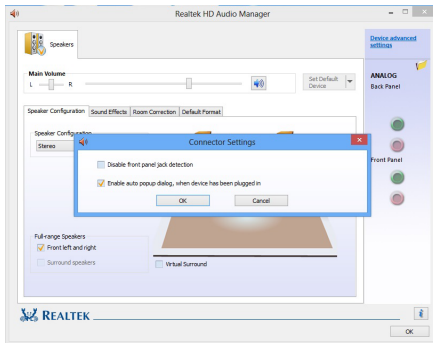

\* For reference only

If you use AC' 97 Front Panel, please don't tick off "Using Front Jack Detect". If you use HD Audio Front Panel, please tick off the option of "Using Front Jack Detect".



\* For reference only

### 7. USB3F: Front Panel USB 3.0 Header

This Motherboard implements one USB 3.0 header supporting 2 extra front USB 3.0 ports, which delivers 5Gb/s transfer rate.

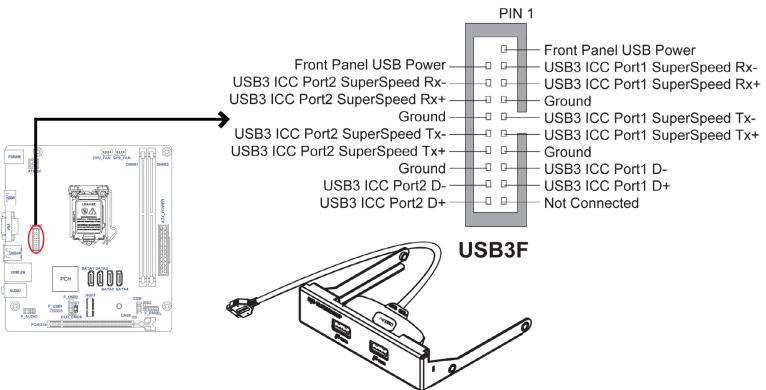

Please make sure that the USB cable has the same pin assignment as indicated above. A different pin assignment may cause damage or system hang-up.



## 2-4-6. Installing a SATA Hard Drive

This section describes how to install a SATA Hard Drive.

### About SATA Connectors

Your motherboard features four SATA connectors supporting a total of four drives. SATA refers to Serial ATA (Advanced Technology Attachment) is the standard interface for the IDE hard drives which are currently used in most PCs. These connectors are well designed and will only fit in one orientation. Locate the SATA connectors on the motherboard and follow the illustration below to install the SATA hard drives.

### Installing Serial ATA Hard Drives

To install the Serial ATA (SATA) hard drives, use the SATA cable that supports the Serial ATA protocol. This SATA cable comes with a SATA power cable. You can connect either end of the SATA cable to the SATA hard drive or the connector on the motherboard.

Refer to the illustration below for proper installation:

- 1 Attach either cable end to the connector on the motherboard.
- 2 Attach the other cable end to the SATA hard drive.
- 3 Attach the SATA power cable to the SATA hard drive and connect the other end to the power supply.

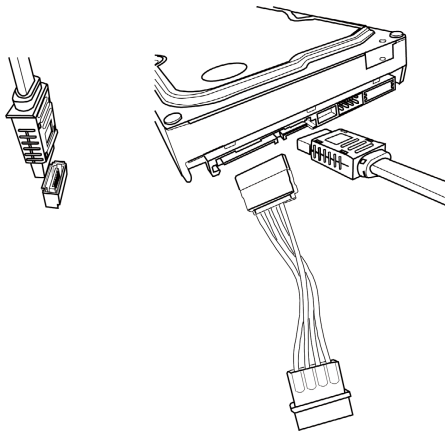

*\* For reference only*

## 2-4-7. Connecting Case Components

After you have installed the motherboard into a case, you can begin connecting the motherboard components. Refer to the following:

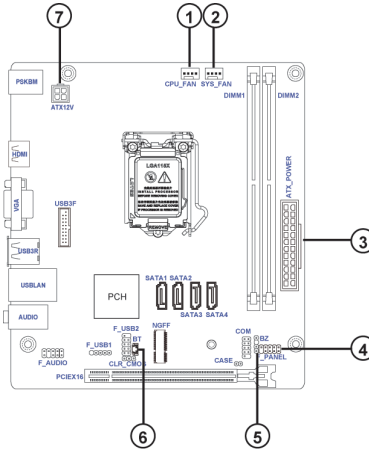

No.	Components	No.	Components
1	CPU_FAN	5	BZ
2	SYS_FAN	6	BT
3	ATX_POWER	7	ATX12V
4	F_PANEL	~	~

### 1. CPU\_FAN (CPU Cooling FAN Power Connector) & 2. SYS\_FAN (System Cooling FAN Power Connector)

Connect the CPU cooling fan cable to **CPU\_FAN**.  
Connect the system cooling fan connector to **SYS\_FAN**.

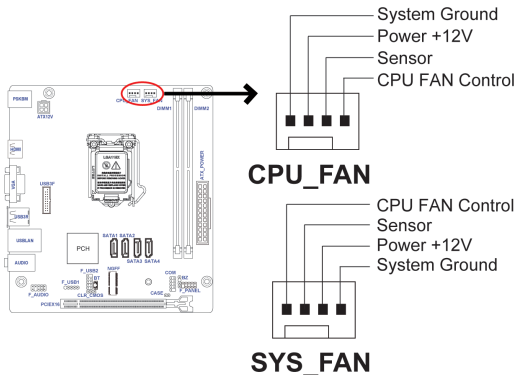

Users please note that the fan connector supports the CPU cooling fan of 1.1A ~ 2.2A (26.4W max) at +12V.

### 3. ATX\_POWER (ATX 24-pin Power Connector) & 7. ATX12V (ATX 12V Power Connector)

Connect the standard power supply connector to **ATX\_POWER**.  
Connect the auxiliary case power supply connector to **ATX12V**.

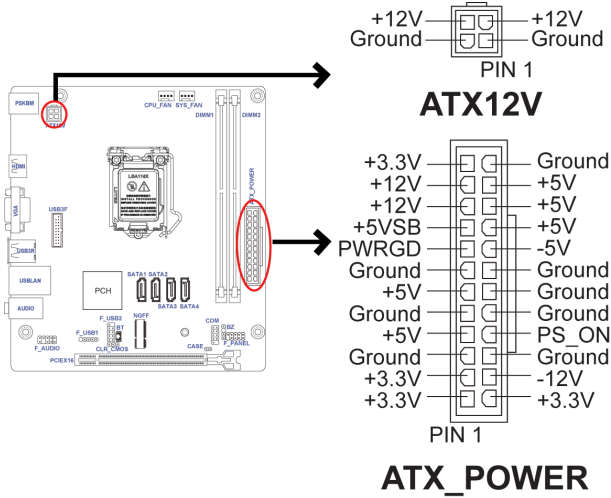

#### Connecting 24-pin power cable

The ATX 24-pin connector allows you to connect to ATX\_POWER power supply.

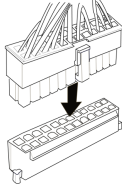

24-pin power cable

With ATX\_POWER power supply, users please note that when installing 24-pin power cable, the latches of power cable and the ATX\_POWER match perfectly.



#### Connecting 4-pin power cable

The ATX12V power connector is used to provide power to the CPU.

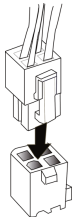

4-pin power cable

When installing 4-pin power cable, the latches of power cable and the ATX12V match perfectly.

#### 4. F\_PANEL: Front Panel Header

The front panel header (F\_PANEL) provides a standard set of switch and LED headers commonly found on Mini ITX case. Refer to the table below for information:

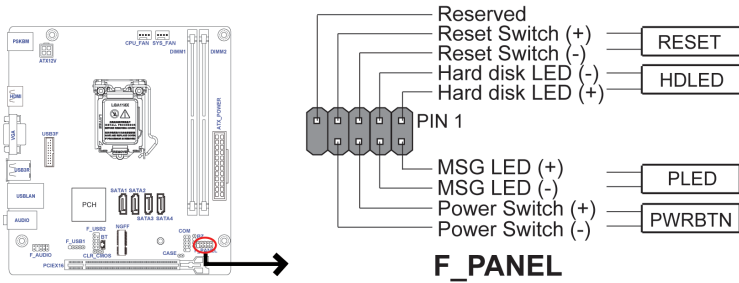

##### **Hard Drive Activity LED**

Connecting pins 1 and 3 to a front panel mounted LED provides visual indication that data is being read from or written to the hard drive. For the LED to function properly, an IDE drive should be connected to the onboard IDE interface. The LED will also show activity for devices connected to the SCSI (hard drive activity LED) connector.

##### **Power/Sleep/Message waiting LED**

Connecting pins 2 and 4 to a single or dual-color, front panel mounted LED provides power on/off, sleep, and message waiting indication.

##### **Reset Switch**

Supporting the reset function requires connecting pin 5 and 7 to a momentary-contact switch that is normally open. When the switch is closed, the board resets and runs POST.

##### **Power Switch**

Supporting the power on/off function requires connecting pins 6 and 8 to a momentary-contact switch that is normally open. The switch should maintain contact for at least 50 ms to signal the power supply to switch on or off. The time requirement is due to internal de-bounce circuitry. After receiving a power on/off signal, at least two seconds elapses before the power supply recognizes another on/off signal.

### 5. BZ: Buzzer Header

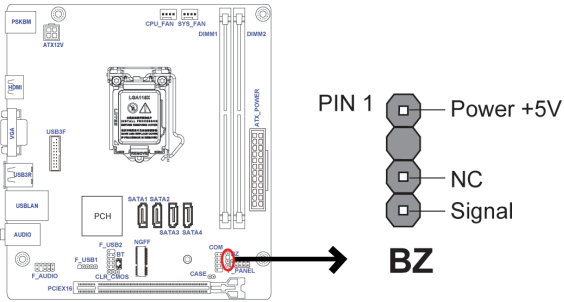

### 6. BT: Battery Header

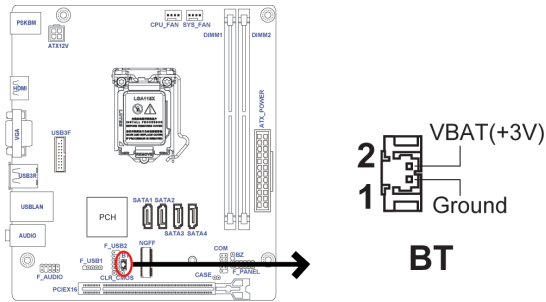

This concludes Chapter 2. The next chapter covers the BIOS.

## Chapter 3

### Using BIOS

---

#### About the Setup Utility

The computer uses the latest “American Megatrends Inc.” BIOS with support for Windows Plug and Play. The CMOS chip on the motherboard contains the ROM setup instructions for configuring the motherboard BIOS.

The BIOS (Basic Input and Output System) Setup Utility displays the system’s configuration status and provides you with options to set system parameters. The parameters are stored in battery-backed-up CMOS RAM that saves this information when the power is turned off. When the system is turned back on, the system is configured with the values you stored in CMOS.

The BIOS Setup Utility enables you to configure:

- Hard drives, diskette drives and peripherals
- Video display type and display options
- Password protection from unauthorized use
- Power Management features

The settings made in the Setup Utility affect how the computer performs. Before using the Setup Utility, ensure that you understand the Setup Utility options.

This chapter provides explanations for Setup Utility options.

#### ***The Standard Configuration***

A standard configuration has already been set in the Setup Utility. However, we recommend that you read this chapter in case you need to make any changes in the future.

This Setup Utility should be used:

- when changing the system configuration
- when a configuration error is detected and you are prompted to make changes to the Setup Utility
- when trying to resolve IRQ conflicts
- when making changes to the Power Management configuration
- when changing the password or making other changes to the Security Setup

#### ***Entering the Setup Utility***

When you power on the system, BIOS enters the Power-On Self Test (POST) routines. POST is a series of built-in diagnostics performed by the BIOS. After the POST routines are completed, the following message appears:

***Press DEL to enter SETUP***

Press the delete key to access BIOS Setup Utility.



### Resetting the Default CMOS Values

When powering on for the first time, the POST screen may show a “CMOS Settings Wrong” message. This standard message will appear following a clear CMOS data at factory by the manufacturer. You simply need to Load Default Settings to reset the default CMOS values.

Note: Changes to system hardware such as different CPU, memories, etc. may also trigger this message.



### Using BIOS

When you start the Setup Utility, the main menu appears. The main menu of the Setup Utility displays a list of the options that are available. A highlight indicates which option is currently selected. Use the cursor arrow keys to move the highlight to other options. When an option is highlighted, execute the option by pressing <Enter>.

Some options lead to pop-up dialog boxes that prompt you to verify that you wish to execute that option. Other options lead to dialog boxes that prompt you for information.

Some options (marked with an icon >>) lead to submenus that enable you to change the values for the option. Use the cursor arrow keys to scroll through the items in the submenu.

In this manual, default values are enclosed in parenthesis. Submenu items are denoted by an icon >>.



*The default BIOS setting for this motherboard apply for most conditions with optimum performance. We do not suggest users change the default values in the BIOS setup and take no responsibility to any damage caused by changing the BIOS settings.*

### BIOS Navigation Keys

The BIOS navigation keys are listed below:

KEY	FUNCTION
<b>ESC</b>	Exits the current menu
↑↓←→	Scrolls through the items on a menu
+/-	Change Opt.
<b>Enter</b>	Select
<b>F1</b>	General Help
<b>F2</b>	Previous Value
<b>F3</b>	Optimized Defaults
<b>F4</b>	Save & Exit



*1. For the purpose of better product maintenance, the manufacture reserves the right to change the BIOS items presented in this manual. The BIOS setup screens shown in this chapter are for reference only and may differ from the actual BIOS. Please visit the manufacture's website for updated manual.*

*2. In this Gui BIOS, you can operate by mouse or keyboard. Click : select item; Double click: enter; Right click: exit.*



## Main Menu

This menu shows the information of BIOS and enables you to set the system language, date and time.

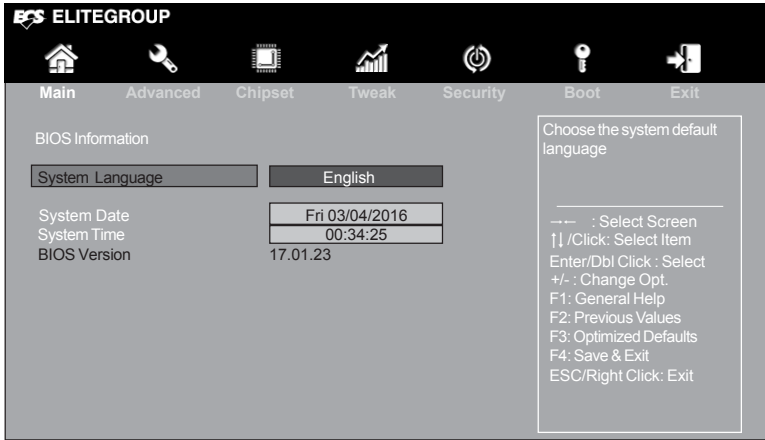

### System Language (English)

This item is used to set system language.

### System Date & Time

The Date and Time items show the current date and time on the computer. If you are running a Windows OS, these items are automatically updated whenever you make changes to the Windows Date and Time Properties utility.

## Advanced Menu

The Advanced menu items allow you to change the settings for the CPU and other system.

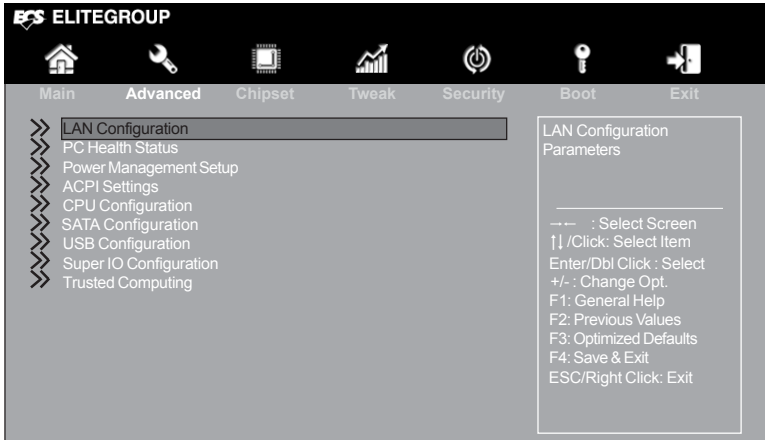

## » LAN Configuration

The item in the menu shows the LAN-related information that the BIOS automatically detects.

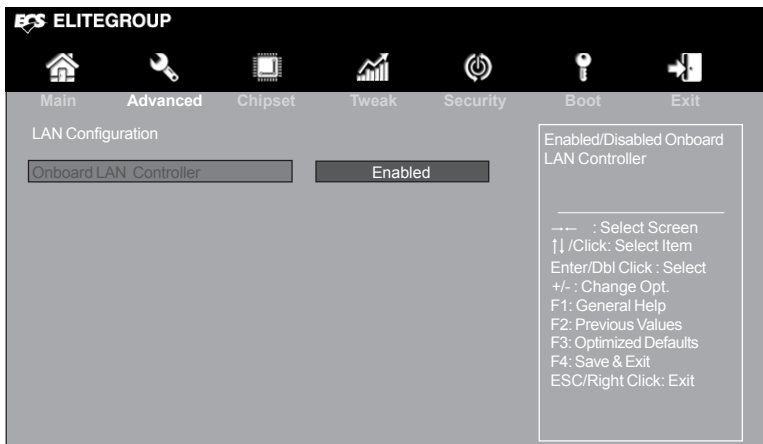

### **Onboard LAN Controller (Enabled)**

Use this item to enable or disable Onboard LAN controller.

Press <Esc> to return to the Advanced Menu page.

## » PC Health Status

On motherboards support hardware monitoring, this item lets you monitor the parameters for critical voltages, temperatures and fan speeds.

**ELITEGROUP**

Main Advanced Chipset Tweak Security Boot Exit

PC Health Status

» Smart Fan Function

CPU Temperature (DTS)	36
System Temperature	39°C
CPU Fan Speed	3000 RPM
System Fan Speed	0 RPM
Core Voltage	1.067V
DIMM Voltage	1.177V
+12V	12.070V
+5VSB	4.900V
+VCC	5.032V
TCC Activation Temperature (DTS)	100

-- : Select Screen  
 ↑ / Click: Select Item  
 Enter / Dbl Click: Select  
 +/- : Change Opt.  
 F1: General Help  
 F2: Previous Values  
 F3: Optimized Defaults  
 F4: Save & Exit  
 ESC / Right Click: Exit

## » Smart Fan Function

Scroll to this item and press <Enter> to view the following screen:

**ELITEGROUP**

Main Advanced Chipset Tweak Security Boot Exit

Smart Fan Select CPU Fan

Smart Fan Mode	Normal
Smart Fan start PWM value	180
Smart Fan start PWM TEMP (DTS)	70
DeltaT	3
Smart Fan Slope PWM value	10
Fan Full Speed Offset (DTS)	77

SmartFan Select

-- : Select Screen  
 ↑ / Click: Select Item  
 Enter / Dbl Click: Select  
 +/- : Change Opt.  
 F1: General Help  
 F2: Previous Values  
 F3: Optimized Defaults  
 F4: Save & Exit  
 ESC / Right Click: Exit

### Smart Fan Select (CPU Fan)

This item allows you to change and configure Smart Fans on M/B. ex. CPU Fan, System Fan.

**Smart Fan Mode (Normal)**

This item allows you to select the fan mode (Normal, Quiet, Silent, or Manual) for a better operation environment. If you choose Normal mode, the fan speed will be auto adjusted depending on the CPU temperature. If you choose Quiet mode, the fan speed will be auto minimized for quiet environment. If you choose Silent mode, the fan speed will be auto restricted to make system more quietly. If you choose Manual mode, the fan speed will be adjust depending on users' parameters.

**Smart Fan start PWM value (180)**

This item is used to set the start PWM value of the smart fan.

**Smart Fan start PWM TEMP (DTS) (70)**

This item is used to set the start temperature of the smart fan.

**DeltaT (3)**

This item specifies the range that controls CPU temperature and keeps it from going so high or so low when smart fan works.

**Smart Fan Slope PWM value (10)**

This item is used to set the Slope Select PWM of the smart fan.

**Fan Full Speed Offset (DTS) (77)**

This item is used to set the fan full speed offset value.

Press <Esc> to return to the PC Health Status page.

**System Component Characteristics**

These items display the monitoring of the overall inboard hardware health events, such as CPU & DIMM voltage, CPU & System fan speed...etc.

- CPU Temperature (DTS)
- System Temperature
- CPU Fan Speed
- System Fan Speed
- Core Voltage
- DIMM Voltage
- +12V
- +5VSB
- +VCC

Press <Esc> to return to the Advanced Menu page.

**TCC Activation Temperature (DTS) (100)**

This item shows the factory TCC activation temperature.

## » Power Management Setup

This page sets up some parameters for system power management operation.

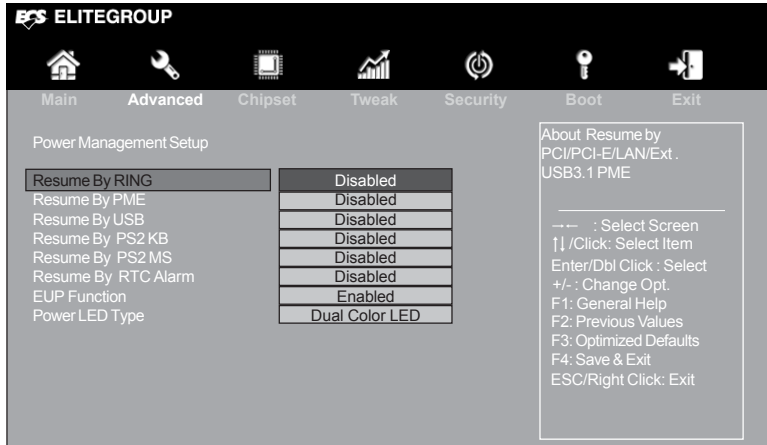

### Resume By Ring (Disabled)

An input signal on the serial Ring Indicator (RI) line (in other words, an incoming call on the modem) awakens the system from a soft off state.

### Resume By PME (Disabled)

The system can be turned off with a software command. If you enable this item, the system can automatically resume if there is an incoming call on the PCI/PCI-E Modem or PCI/PCI-E LAN card. You must use an ATX power supply in order to use this feature. Use this item to do wake-up action if inserting the PCI/PCI-E card.

### Resume By USB (Disabled)

This item allows you to enable or disable the USB device wakeup function from S3 mode.

### Resume By PS2 KB (Disabled)

This item allows you to enable or disable the keyboard activity to awaken the system from power saving mode.

### Resume By PS2 MS (Disabled)

This item allows you to enable or disable the mouse activity to awaken the system from power saving mode.

### Resume By RTC Alarm (Disabled)

The system can be turned off with a software command. If you enable this item, the system can automatically resume at a fixed time based on the system's RTC (realtimeclock). Use the items below this one to set the date and time of the wake-up alarm. You must use an ATX power supply in order to use this feature.

### EUP Function (Enabled)

This item allows user to enable or disable EUP support.

### Power LED Type (Dual Color LED)

This item shows the type of the Power LED.

Press <Esc> to return to the Advanced Menu page.

## >> ACPI Settings

The item in the menu shows the highest ACPI sleep state when the system enters suspend.

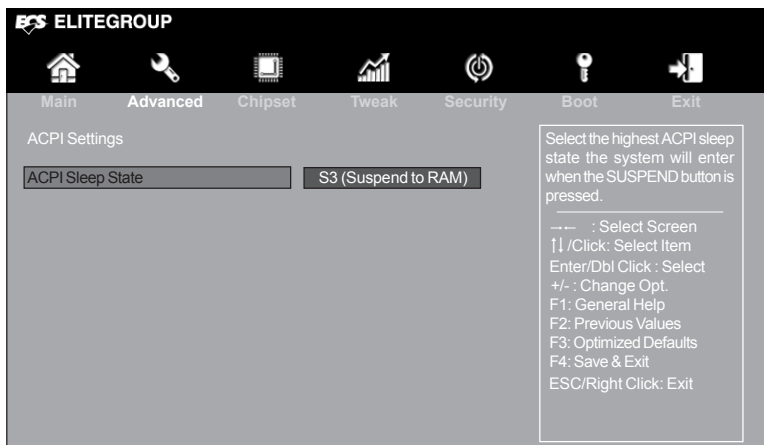

### ACPI Sleep State [S3(Suspend to RAM)]

This item allows user to enter the ACPI S3 (Suspend to RAM) Sleep State (default).

Press <Esc> to return to the Advanced Menu page.

## » CPU Configuration

The item in the menu shows the CPU.

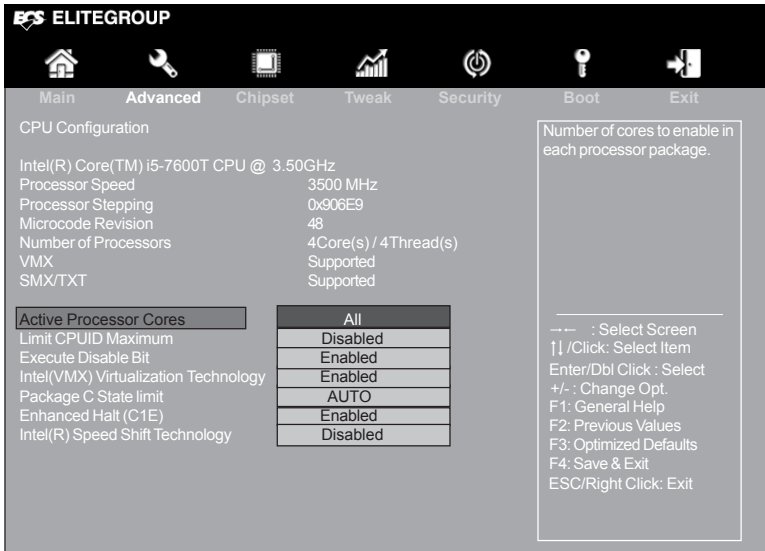

### Intel(R) Core(TM) i5-7600T CPU @ 3.50GHz

This is display-only field and displays the information of the CPU installed in your computer.

### Processor Speed (3500MHz)

This item shows the current processor speed.

### Processor Stepping (0x906E9)

This item shows the processor stepping version.

### Microcode Revision (48)

This item shows the Microcode version.

### Number of Processors (4Core(s) / 4Thread(s))

This item shows the core number of the processor.

### VMX (Supported)

This item shows the CPU Support Intel VMX(Virtual-Machine Extensions) Technology.

### SMX/TXT (Supported)

This item shows the computer support Intel SMX/TXT Technology.

### Active Processor Cores (All)

Use this item to control the number of active processor cores.

### Limit CPUID Maximum (Disabled)

Use this item to enable or disable the maximum CPUID value limit, you can enable this item to prevent the system from "rebooting" when trying to install Windows NT 4.0.



**Execute Disable Bit (Enabled)**

This item allows the processor to classify areas in memory by where application code can execute and where it cannot. When a malicious worm attempts to insert code in the buffer, the processor disables code execution, preventing damage or worm propagation. Replacing older computers with Execute Disable Bit enabled systems can halt worm attacks, reducing the need for virus related repair.

**Intel (VMX) Virtualization Technology (Enabled)**

When disabled, a VMM cannot utilize the additional hardware capabilities provided by Vanderpool Technology.

**Package C State limit (AUTO)**

Use this item to set the package C state limit.

**Enhanced Halt (C1E) (Enabled)**

Use this item to enable the CPU energy-saving function when the system is not running.

**Intel(R) Speed Shift Technology (Disabled)**

Use this item to enable or disable the Intel(R) Speed Shift Technology.

Press <Esc> to return to the Advanced Menu page.

## » SATA Configuration

Use this item to show the mode of serial SATA configuration options.

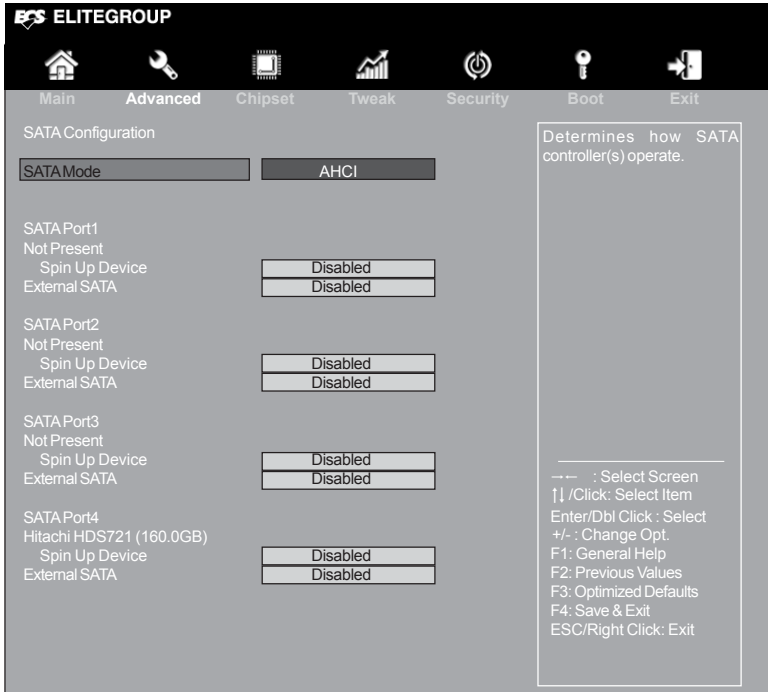

### SATA Mode (AHCI)

Use this item to select SATA mode.

### SATA Port 1~4 (Not Present/Hitachi HDS721 (160.0GB))

This motherboard supports four SATA channels, each channel allows one SATA device to be installed. Use these items to configure each device on the SATA channel.

### Spin Up Device (Disabled)

Use this item to enable or disable the spin up device.

### External SATA (Disabled)

Use this item to enable or disable the external SATA.

Press <Esc> to return to the Advanced Menu page.

## >> USB Configuration

Use this item to show the information of USB configuration.

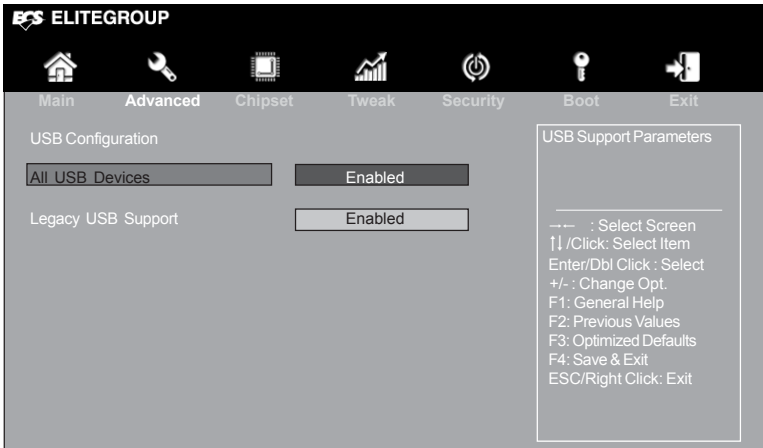

### All USB Devices (Enabled)

Use this item to enable or disable all USB devices.

### Legacy USB Support (Enabled)

Use this item to enable or disable support for legacy USB devices.

Press <Esc> to return to the Advanced Menu page.

## » Super IO Configuration

Use this item to show the information of Super IO configuration.

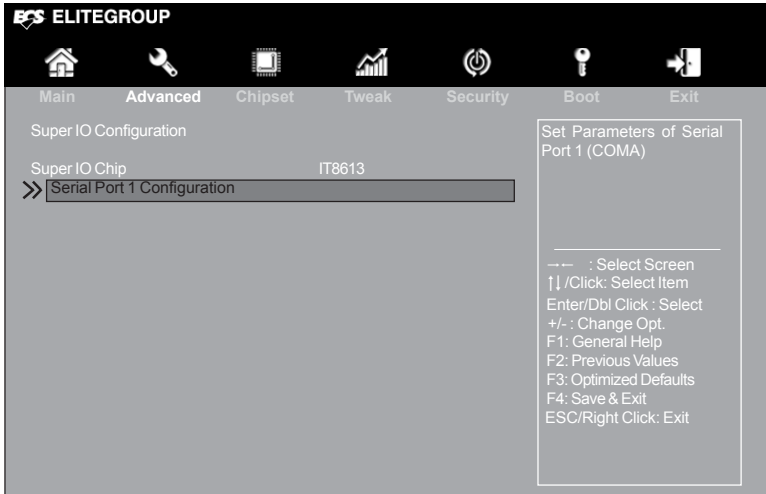

### Super IO Chip (IT8613)

This item shows the information of the super IO chip.

#### » Serial Port 1 Configuration

Scroll to this item and press <Enter> to view the following screen:

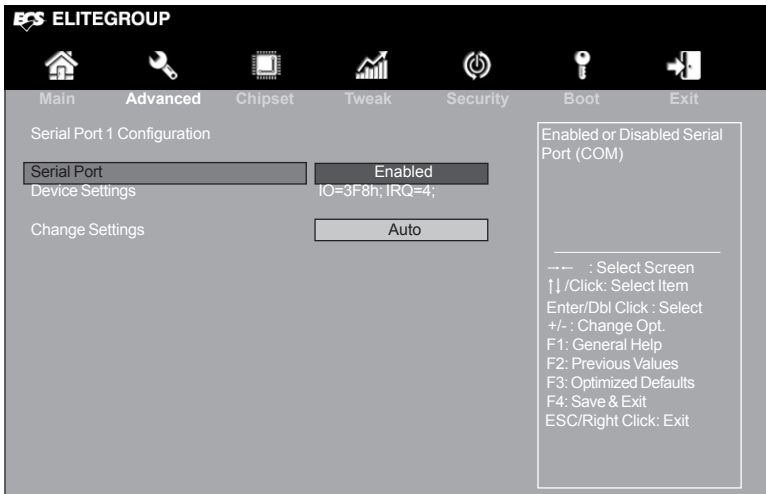

### Serial Port (Enabled)

This item allows you to enable or disable serial port.

***Device Settings (IO=3F8h; IRQ=4;)***

This item shows the information of the device settings.

***Change Settings (Auto)***

Use this item to change device settings.

Press <Esc> to return to the Super IO Configuration page.

Press <Esc> to return to the Advanced Menu page.

## » Trusted Computing

Use this item to show the information of trusted computing configuration.

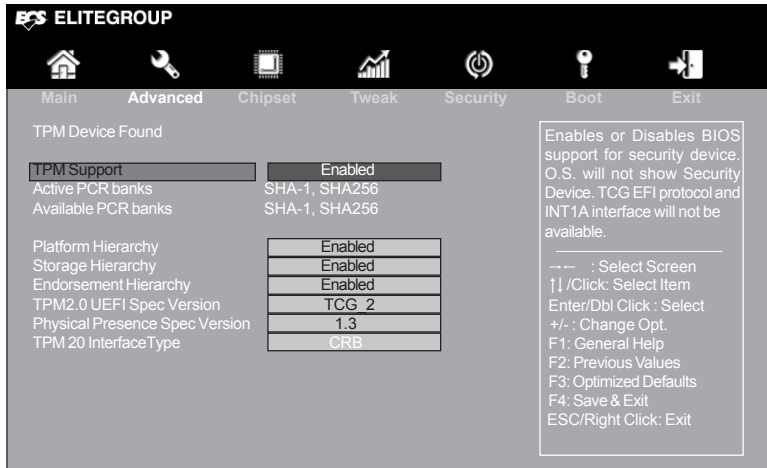

### **TPM Support (Enabled)**

Use this item to enable or disable the TPM port. O.S. will not show TPM. Reset of platform is required.

### **Active PCR banks (SHA-1, SHA-256)**

Use this item to show the Active PCR banks.

### **Available PCR banks (SHA-1, SHA-256)**

Use this item to show the Available PCR banks.

### **Platform Hierarchy (Enabled)**

Use this item to enable or disable the Platform Hierarchy.

### **Storage Hierarchy (Enabled)**

Use this item to enable or disable the Storage Hierarchy.

### **Endorsement Hierarchy (Enabled)**

Use this item to enable or disable the Endorsement Hierarchy.

### **TPM2.0 UEFI Spec Version (TCG\_2)**

Use this item to show the TPM2.0 UEFI Spec Version.

### **Physical Presence Spec Version (1.3)**

Use this item to show the Physical Presence Spec Version.

### **TPM 20 InterfaceType (CRB)**

Use this item to show the TPM 20 InterfaceType.

Press <Esc> to return to the Advanced Menu page.

## Chipset Menu

The chipset menu items allow you to change the settings for the North Bridge chipset, South Bridge chipset and other system.

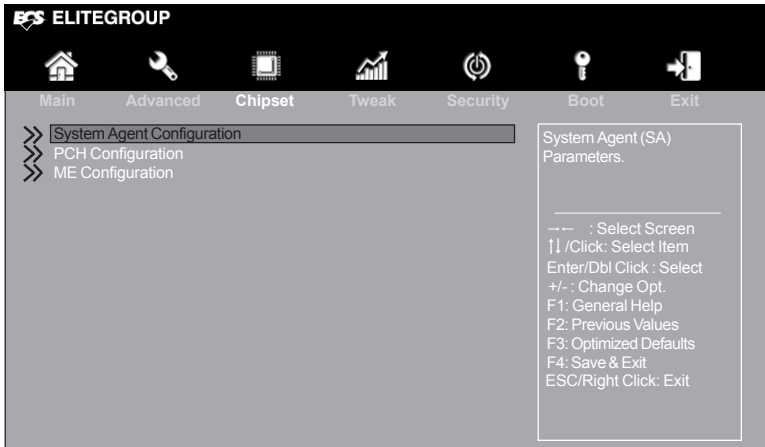

### >> System Agent Configuration

Scroll to this item and press <Enter> to view the following screen:

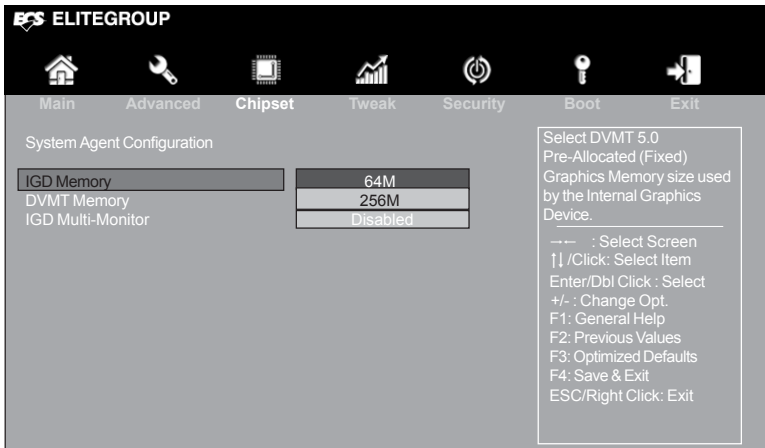

#### IGD Memory (64M)

This item shows the information of the IGD (Internal Graphics Device) memory.

#### DVMT Memory (256M)

When set to DVMT Mode, the graphics chip will dynamically allocate system memory as graphics memory, according to system and graphics requirements.

### IGD Multi-Monitor (Disabled)

This item allows you to enable or disable the IGD Multi-Monitor.

Press <Esc> to return to the Chipset Menu page.

### Multi-Monitor technology

Multi-Monitor technology can help you to increase the area available for programs running on a single computer system through using multiple display devices.

It is not only to increase larger screen viewing but also to improving personal productivity.

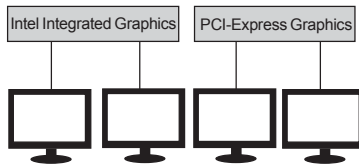

*Please note that Multi-Monitor technology supports up to four monitors: one or two Intel integrated Graphics and one or two PCI-Express graphics devices under Windows 7/8.1/10.*

Step 1. Insert ECS drives DVD to run Auto setup or browse the DVD to install Intel chipset drivers, VGA and sound drivers.(If you want know the detail information, please refer to chapter 4.)





Step 2. Install all the drivers of PCI-Express graphic cards. Click the Browse CD item, then appears the following screen. Select the driver you want to install(e.g NVIDIA GeForce 8400 GS(Microsoft Corporation-WDDM v1.1)) and double click it.

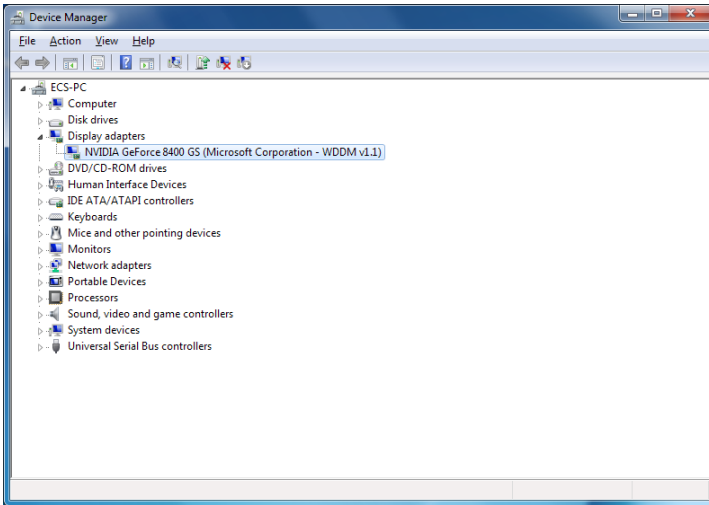

Step 3. Enable IGD Multi-Monitor from BIOS. In the following BIOS screen, please set IGD Multi-Monitor to [Enabled].

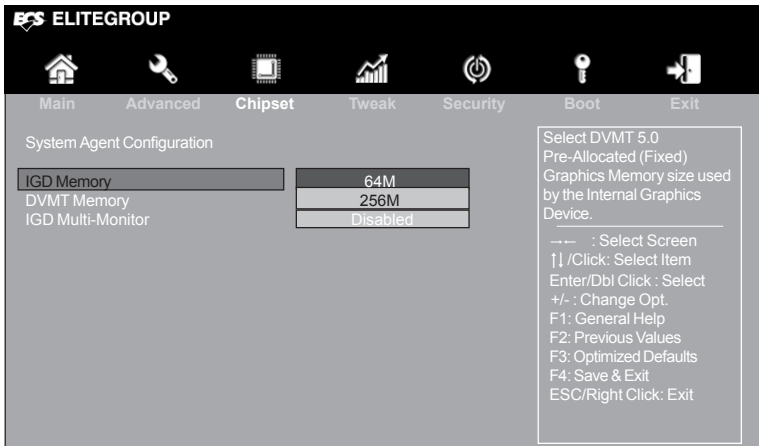

Step 4. Change the appearance of your displays under Windows 7/8/8.1.

1. Enter the Control Panel menu, select the Display in the All Control Panel Items and click the Screen Resolution, then appears the following screen.

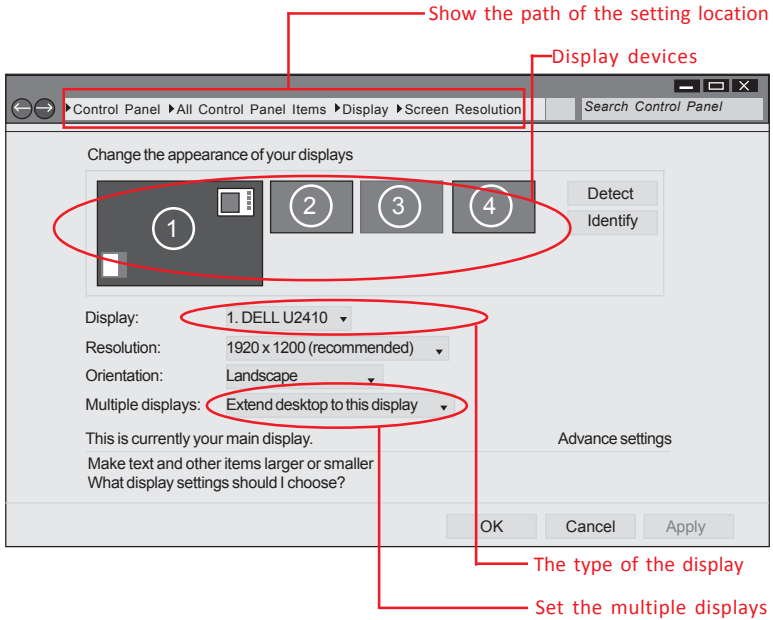

2. Select display devices, set the multiple displays option and to extend desktop for display "Multi-Monitor technology".

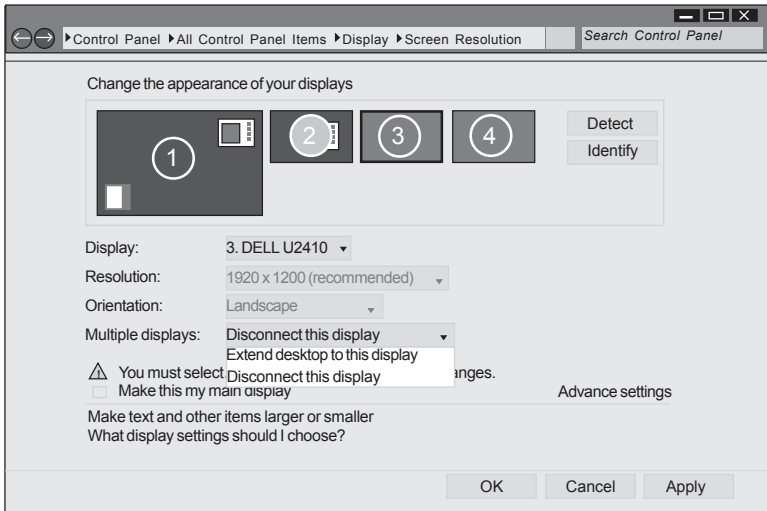

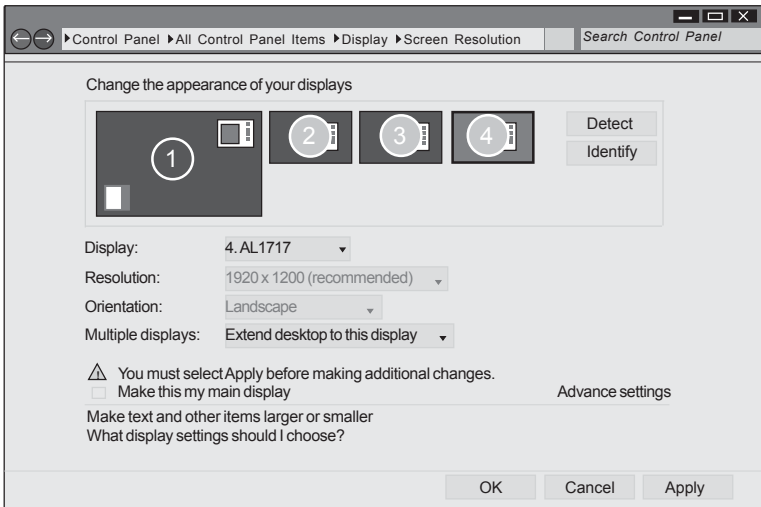
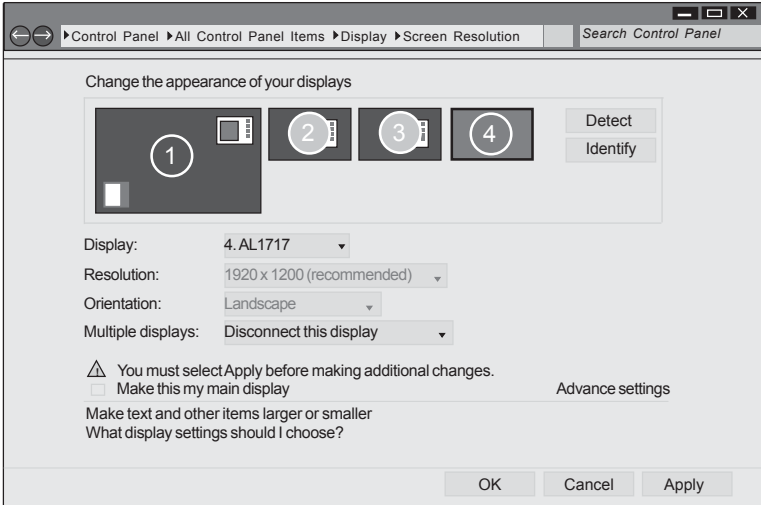

## >>PCH Configuration

Scroll to this item and press <Enter> to view the following screen:

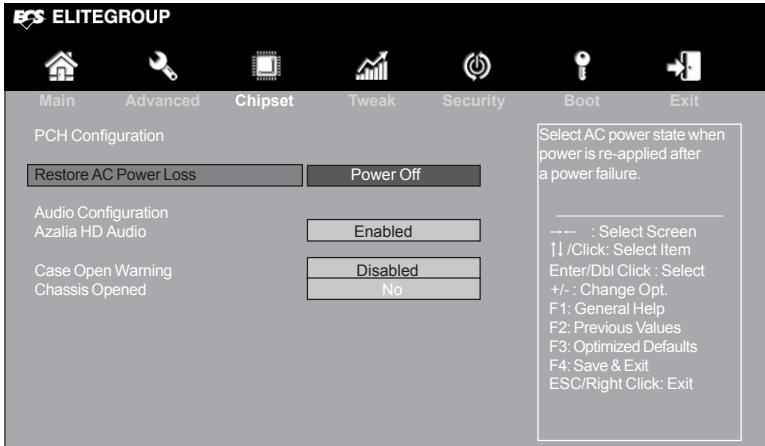

### **Restore AC Power Loss (Power Off)**

This item enables your computer to automatically restart or return to its operating status.

### **Azalia HD Audio (Enabled)**

This item enables or disables Azalia HD audio.

### **Case Open Warning (Disabled)**

This item enables or disables the warning if the case is opened up, and the item below indicates the current status of the case.

### **Chassis Opened (No)**

This item indicates whether the case has been opened.

Press <Esc> to return to the Chipset Menu page.

## >> ME Configuration

Scroll to this item and press <Enter> to view the following screen:

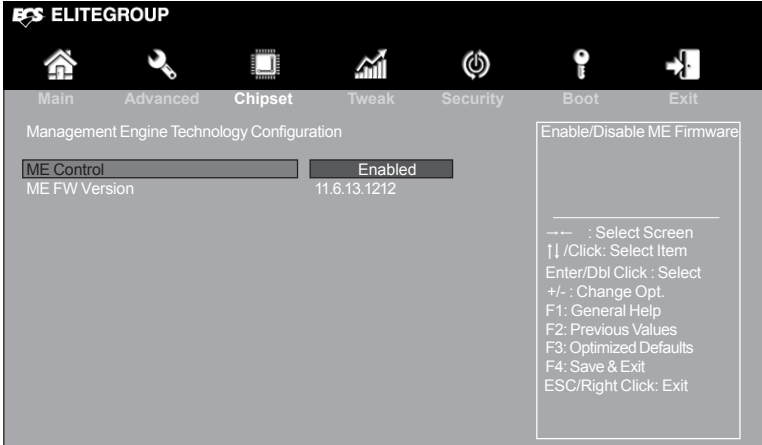

### ME Control (Enabled)

Use this item to enable or disable the ME Firmware.

### ME FW Version (11.6.13.1212)

This item shows the ME FW version.

Press <Esc> to return to the Chipset Menu page.

### Tweak Menu

This page enables you to set the clock speed and system bus for your system. The clock speed and system bus are determined by the kind of processor you have installed in your system.

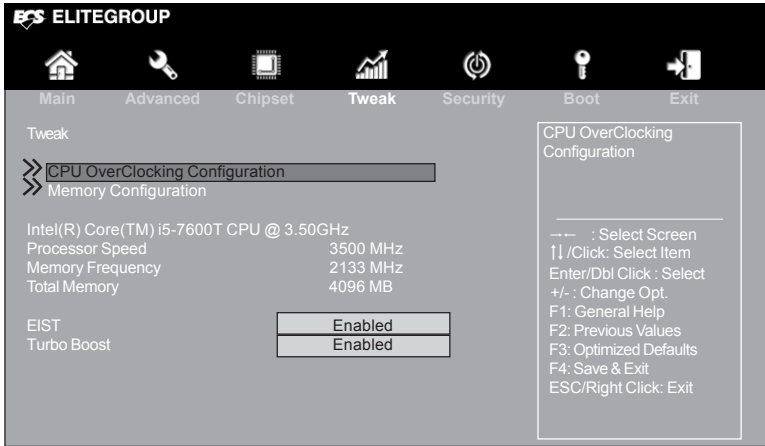

### » CPU OverClocking Configuration

Scroll to this item to view the following screen:

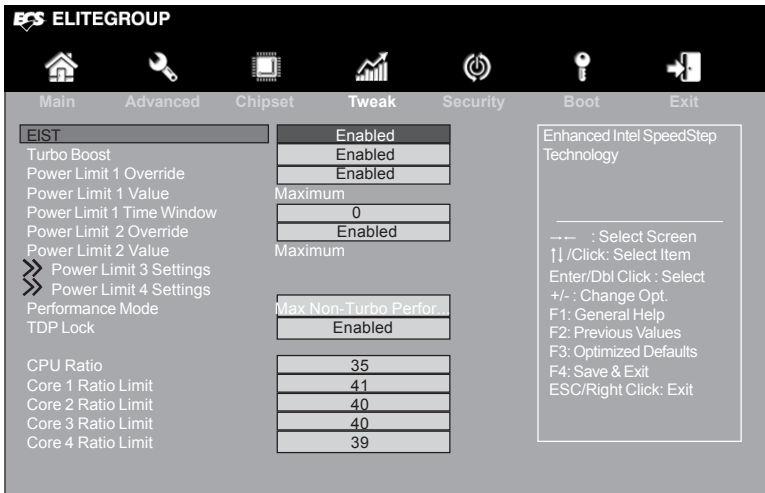

#### EIST (Enabled)

This item allows users to enable or disable the EIST (Enhanced Intel SpeedStep Technology).

#### Turbo Boost (Enabled)

This item allows you to enable or disable turbo boost.

**Power Limit 1/2 Override (Enabled)**

Use these items to enable or disable the Power Limit 1/2 Override. If these options are disabled, BIOS will program the default values for Power Limit 1/2.

**Power Limit 1/2 Value (Maximum)**

Use these items to control the limit of the TDP. These are for Turbo mode.

**Power Limit 1 Window (0)**

Power limit 1 Time Window value in seconds. The value may vary from 0 to 128. If the value is 0, default values will be programmed (28 sec for Mobile and 1 sec for Desktop). Indicates the time window over which TDP value should be maintained.

**Power Limit 3 Settings**

Use this item to enable or disable the power limit 3 override. If this option is disabled, BIOS will leave the default values for power limit 3 and power limit 3 time window.

**Power Limit 4 Settings**

Use this item to enable or disable the power limit 4 override. If this option is disabled, BIOS will leave the default values for power limit 4.

**Performance Mode (Max Non-Turbo Perfor...)**

Use this item to select the performance state that the BIOS will set before OS handoff.

**TDP Lock (Enabled)**

This item allows you to enable or disable the Package TDP lock.

**CPU Ratio (35)**

This item allows you to control CPU ratio.

**Core 1 /2 /3 /4 Ratio Limit (41/40/40/39)**

Use these items to set the Core Ratio Limit Value.

Press <Esc> to return to the Tweak Menu page.

## » Memory Configuration

Scroll to this item to view the following screen:

**ELITEGROUP**

Main Advanced Chipset **Tweak** Security Boot Exit

Memory Information

Memory Profiles			Default profile
Memory Frequency			2133

Timing	Default	Current	Target
Command Rate	1	2	1
tCL	15	15	15
tRCD/tRP	15	15	15
tRAS	36	36	36
tRFC1	278	278	278
tWR	16	16	16
tWTR_L	8	8	8
tWTR_S	3	3	3
tRRD_L	6	6	6
tRRD_S	4	4	4
tRTP	8	8	8
tFAW	23	23	23
tCWL	14	14	14
tREFI	8325	8325	8325
tRC	50	50	50
tCCD_L	6	6	6

Advanced Timing Configuration		
tCKE	6	0
tRDRD_dr	6	0
tRDRD_dd	7	0
tRDRD_sg	6	0
tRDRD_dg	4	0
tWRWR_dr	7	0
tWRWR_dd	7	0
tWRWR_sg	6	0
tWRWR_dg	4	0

Select DIMM timing profile.  
The below values start with the currently running values and don't auto populate.

← : Select Screen  
↑/Click: Select Item  
Enter/Dbf Click : Select  
+/- : Change Opt.  
F1: General Help  
F2: Previous Values  
F3: Optimized Defaults  
F4: Save & Exit  
ESC/Right Click: Exit



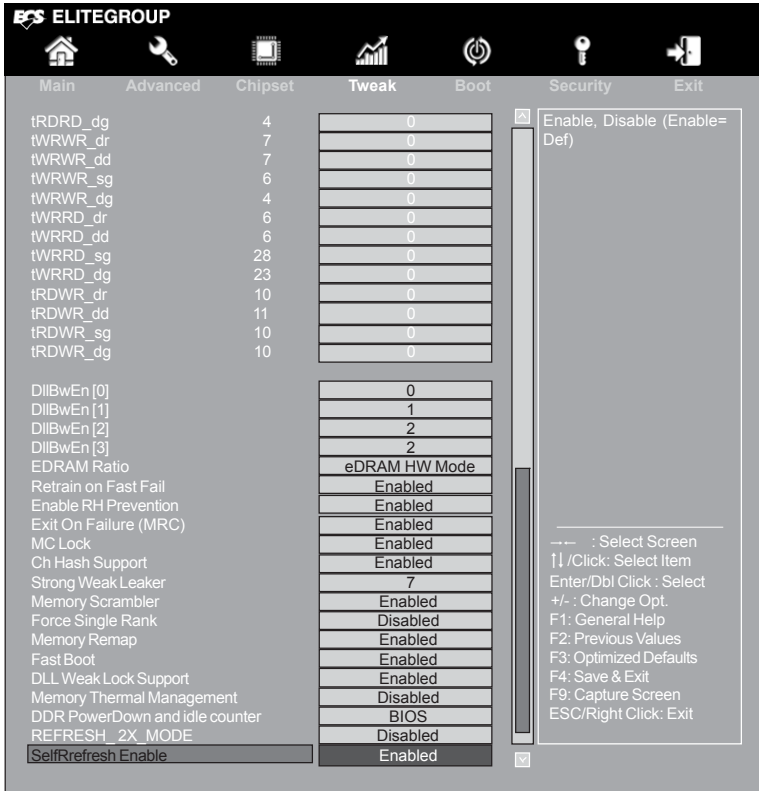

### Memory Profiles (Default profile)

This item enables you to set the memory profiles. The selection of memory profiles impacts memory sizing behavior.

### Memory Frequency (2133)

This item shows the memory frequency.

### DllBwEn [0/1/2/3] (0/1/2/2)

Use these items to set the DllBwEn value.

### EDRAM Ratio (Auto)

Use this item to set the EDRAM Ratio.

### Retrain on Fast Fail (Enabled)

Use this item to enable or disable the retrain on fast fail.

### Enable RH Prevention (Disabled)

Use this item to enable or disable the RH prevention.

### Exit On Failure (MRC) (Enabled)

Use this item to enable or disable the exit on failure (MRC).

### MC Lock (Enabled)

This item allows you to enable or disable capacity to lock MC registers or not.

**Ch Hash Support (Enabled)**

Use this item to enable or disable the Ch Hash support.

**Strong Weak Leaker (7)**

Use this item to set the strong weak leaker value.

**Memory Scrambler (Enabled)**

This item allows you to enable or disable the memory scrambler.

**Force Single Rank (Disabled)**

Use this item to enable or disable the force single rank.

**Memory Remap (Enabled)**

This item allows you to enable or disable the memory remap above 4G.

**Fast Boot (Enabled)**

This item allows you to enable or disable the fast boot.

**DLL Weak Lock Support (Enabled)**

This item allows you to enable or disable the DLL weak lock support.

**Memory Thermal Management (Disabled)**

This item allows you to enable or disable the memory thermal management.

**DDR PowerDown and idle counter (BIOS)**

This item allows you to BIOS or PCODE the DDR Power Down and idle counter. BIOS: BIOS is in control of DDR CKE mode and idle timer value. PCODE: pcode will manage the modes.

**REFRESH\_2X\_MODE (Disabled)**

This item allows you to enable or disable 2xRef when warm and Hot 2-iMC enables 2xRef when Hot.

**SelfRefresh Enable (Enabled)**

Use this item to enable or disable the SelfRefresh.

Press <Esc> to return to the Tweak Menu page.

**Intel(R) Core(TM) i5-7600T CPU @ 3.50GHz**

This is display-only field and displays the information of the CPU installed in your computer.

**Processor Speed (3500 MHz)**

This item shows the CPU speed.

**Memory Frequency (2133 MHz)**

This item shows the memory frequency.

**Total Memory (4096 MB)**

This item shows the total memory.

**EIST (Enabled)**

This item allows users to enable or disable the EIST (Enhanced Intel SpeedStep Technology).

**Turbo Boost (Enabled)**

This item allows you to enable or disable the Turbo Boost.



*Warning: Over-clocking components can adversely affect the reliability of the system and introduce errors into your system. Over-clocking can permanently damage the motherboard by generating excess heat in components that are run beyond the rated limits.*

**Fail-Safe Procedures for Over-clocking**

When end-users encounter failure after attempting over-clocking, please take the following steps to recover from it.

1. Shut down the computer.
2. Press and hold the “Page Up Key (PgUp)” of the keyboard, and then boot the PC up.
3. Two seconds after the PC boots up, release the “Page Up Key (PgUp)”.
4. The BIOS returns to the default setting by itself.

## Security Menu

This page enables you to set setup administrator password and user password.

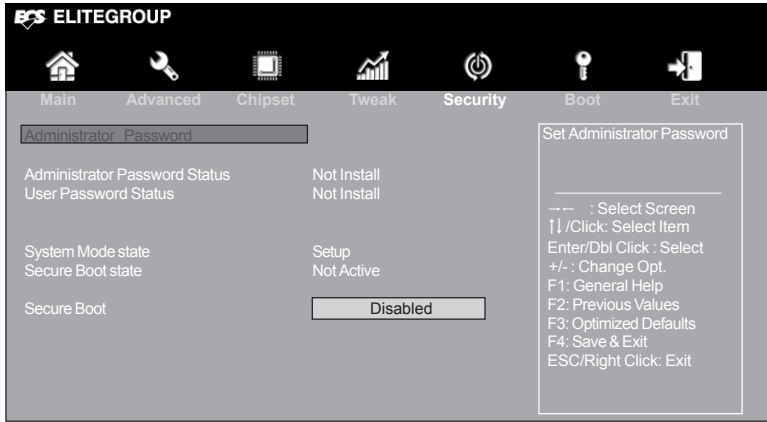

### Administrator Password Status (Not Install)

This item shows administrator password installed or not.

### User Password Status (Not Install)

This item shows user password installed or not.

### System Mode state (Setup)

This item shows system mode setup or not.

### Secure Boot state (Not Active)

This item allows you to enable or disable the secure boot state.

### Secure Boot (Disabled)

This item is used to control the secure boot flow, it is possible only if system runs in User Mode.

## Boot Menu

This page enables you to set the keyboard NumLock state.

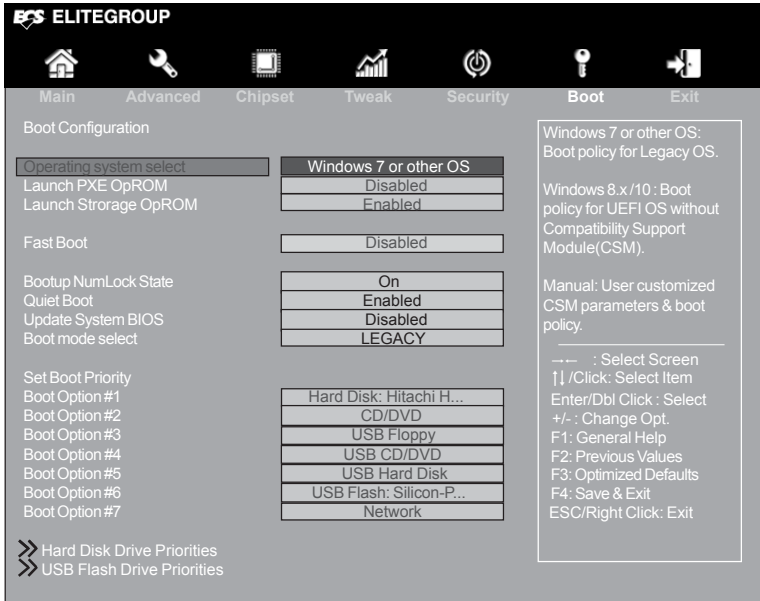

### Operating system select (Windows 7 or other OS)

This item is used to select the operating system.

### Launch PXE OpROM (Disabled)

The item enables or disables launch PXE Option ROM.

### Launch Storage OpROM (Enabled)

Use this item to enable or disable the Storage OpROM.

### Fast Boot (Disabled)

This item enables or disables boot with initialization of a minimal set of device required to launch active boot option. Has no effect for BBS boot options.

### Bootup NumLock State (On)

This item enables you to select NumLock state.

### Quiet Boot (Enabled)

This item enables or disables quiet boot.

### Update System BIOS (Disabled)

This item enables or disables to update system BIOS.

### Boot mode select (LEGACY)

Use this item to select boot mode.

### Boot Option #1 /2 /3 /4 /5 /6 /7

These items show the boot priorities.

### Hard Disk Drive Priorities

This item enables you to specify the sequence of loading the operating system from the installing Hard Disk drives. Press <Enter> to see the submenu.

### **USB Flash Drive Priorities**

This item enables you to specify the sequence of loading the operating system from the installing USB Flash drives. Press <Enter> to see the submenu.

## Exit Menu

This page enables you to exit system setup after saving or without saving the changes.

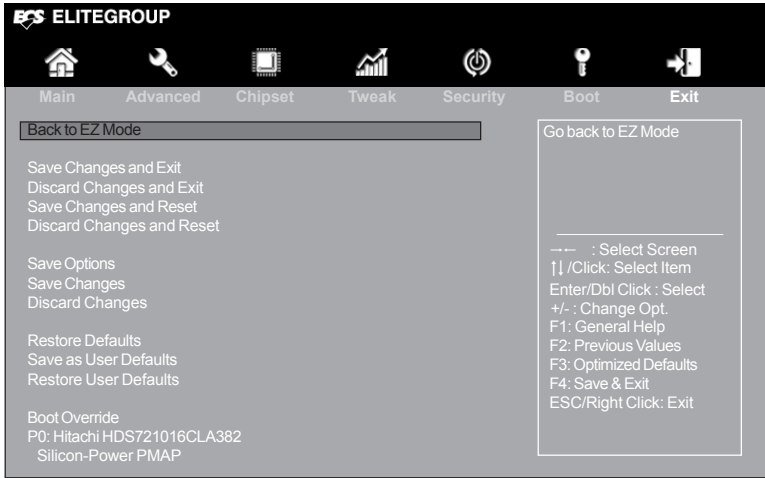

### Back to EZ Mode

This item enables you to back to EZ mode.

### Save Changes and Exit

This item enables you to exit the system setup after saving the changes.

### Discard Changes and Exit

This item enables you to exit system setup without saving any changes.

### Save Changes and Reset

This item enables you to reset system setup after saving the changes.

### Discard Changes and Reset

This item enables you to reset system setup without saving any changes.

### Save Options

This item enables you to save the options that you have made.

### Save Changes

This item enables you to save the changes that you have made.

### Discard Changes

This item enables you to discard any changes that you have made.

### Restore Defaults

This item enables you to restore the system defaults.

### Save as User Defaults

This item enables you to save the changes that you have made as user defaults.

### Restore User Defaults

This item enables you to restore user defaults to all the setup options.

### Boot Override

Use this item to select the boot device.

### **Updating the BIOS**

You can download and install updated BIOS for this motherboard from the manufacturer's Website. New BIOS provides support for new peripherals, improvements in performance, or fixes for known bugs. Install new BIOS as follows:

- 1 If your motherboard has a BIOS protection jumper, change the setting to allow BIOS flashing.
- 2 If your motherboard has an item called Firmware Write Protect in Advanced BIOS features, disable it. (Firmware Write Protect prevents BIOS from being overwritten.)
- 3 Prepare a bootable device or create a bootable system disk. (Refer to Windows online help for information on creating a bootable system disk.)
- 4 Download the Flash Utility and new BIOS file from the manufacturer's Web site. Copy these files to the bootable device.
- 5 Turn off your computer and insert the bootable device in your computer. (You might need to run the Setup Utility and change the boot priority items on the Advanced BIOS Features Setup page, to force your computer to boot from the bootable device first.)
- 6 At the C:\ or A:\ prompt, type the Flash Utility program name and the file name of the new BIOS and then press <Enter>. Example: AFUDOS.EXE 040706.ROM
- 7 When the installation is complete, remove the bootable device from the computer and restart your computer. If your motherboard has a Flash BIOS jumper, reset the jumper to protect the newly installed BIOS from being overwritten. The computer will restart automatically.

This concludes Chapter 3. Refer to the next chapter for information on the software supplied with the motherboard.



*Memo*

# Chapter 4

## Using the Motherboard Software

### Auto-installing under Windows 10/8.1/7

The auto-install DVD-ROM makes it easy for you to install the drivers and software. The support software DVD-ROM disc loads automatically under Windows 10/8.1/7. When you insert the DVD-ROM disc in the DVD-ROM drive, the auto-run feature will automatically bring up the installation screen. The screen has four buttons on it: **Setup**, **Utilities**, **Browse CD** and **Exit**.



**Information:**  
Displays the path for all software and drivers available on the disk.

Click **“Exit”** button to close the Auto-Setup window.

**Browse CD:**  
Open Windows Explorer and show the contents of the support disk.

Click the **“Setup”** button to select and run the software installation program.

Click the **“Utilities”** button to select and install ECS Intelligent Utility.

### Running Setup

Follow these instructions to install device drivers and software for the motherboard:

1. Click **Setup**. The installation program begins:

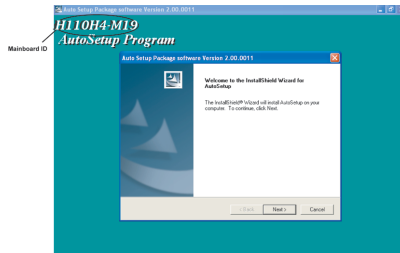

The following screens are examples only. The screens and driver lists will be different according to the motherboard you are installing.

The motherboard identification is located in the upper left-hand corner.

2. Click **Next**. The following screen appears:

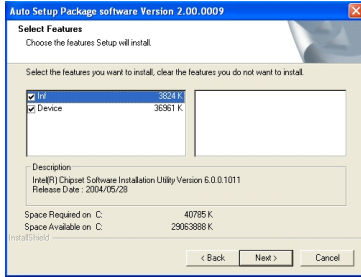

3. Check the box next to the items you want to install. The default options are recommended.
4. Click **Next** to run the Installation Wizard. An item installation screen appears:

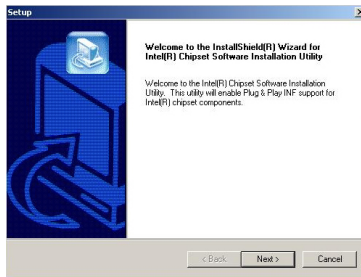

5. Follow the instructions on the screen to install the items.



*Drivers and software are automatically installed in sequence. Follow the onscreen instructions, confirm commands and allow the computer to restart a few times to complete the installation.*

*Windows 8.1 will show the following screen after system restart, you must select "Desktop" in the bottom left to install the next driver.*



Windows 7/8.1 will appear below UAC (User Account Control) message after the system restart. You must select “Yes” to install the next driver. Continue this process to complete the drivers installation.

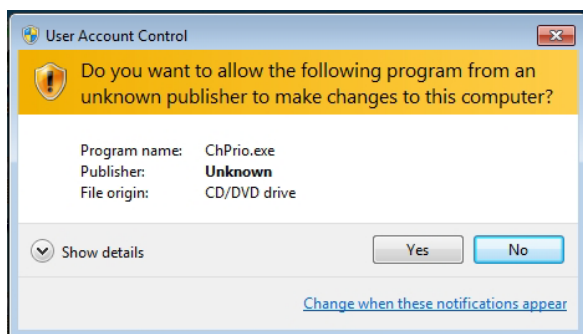

## Manual Installation

If the auto-install DVD-ROM does not work on your system, you can still install drivers through the file manager for your OS (for example, Windows Explorer). Look for the chipset and motherboard model, and then browse to the directory and path to begin installing the drivers. Most drivers have a setup program (SETUP.EXE) that automatically detects your operating system before installation. Other drivers have the setup program located in the operating system subfolder.

If the driver you want to install does not have a setup program, browse to the operating system subfolder and locate the readme text file (README.TXT or README.DOC) for information on installing the driver or software for your operating system.

## ECS Utility Software (Intelligent EZ Utility)

ECS Intelligent EZ Utility provides friendly interfaces under Windows O.S, which makes your computing more easily and conveniently.



*These software(s) are subject to change at anytime without prior notice. Please refer to the support disk for available software.*

## eSF

eSF(Smart Fan) utility provides easy and safe way to adjust fan speed in accordance with your PC's system loading and temperature.

It has five modes to adjust fan speed in a safe range without entering the BIOS to optimize your system cooling environment.

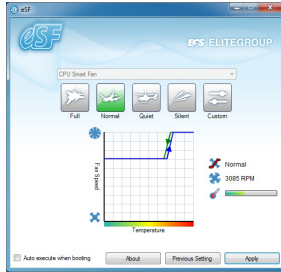

Microsoft .NET Framework 3.5 is required.

## eDLU

ECS eDLU utility makes updating drivers fast and easy. eDLU saves time and hassle by listing all the latest drivers online. Just select the one you prefer and start to download and install the drivers.

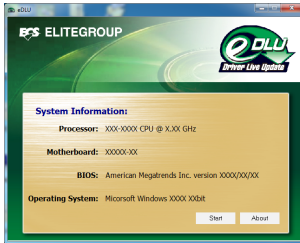

## eBLU

ECS eBLU utility makes BIOS update faster and easier. eBLU will list the latest BIOS with a default check-mark. Click "install" button to install.

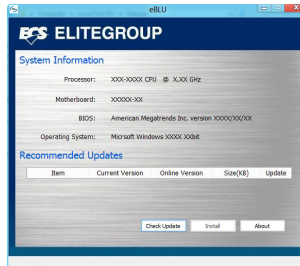

Microsoft .NET Framework 3.5 is required.

## Chapter 5

### ***Trouble Shooting***

---

#### **Start up problems during assembly**

After assembling the PC for the first time you may experience some start up problems. Before calling for technical support or returning for warranty, this chapter may help to address some of the common questions using some basic troubleshooting tips. You may also log onto our ECS website for more information: [http:// www.ecs.com.tw/ECSWebSite/Support/Support\\_FAQ.aspx?MenuID=49&childid=M\\_49&lanID=0](http://www.ecs.com.tw/ECSWebSite/Support/Support_FAQ.aspx?MenuID=49&childid=M_49&lanID=0)

#### ***a) System does not power up and the fans are not running.***

1. Disassemble the PC to remove the VGA adaptor card, DDR memory, LAN, USB and other peripherals including keyboard and mouse. Leave only the motherboard, CPU with CPU cooler and power supply connected. Make sure the power cord is plugged into the wall socket & the switch on the Power Supply Unit (PSU) is turned " on " as well. Turn on again to see if the CPU and power supply fans are running.
2. Make sure to remove any unused screws or other metal objects such as screwdrivers from the inside PC case. This is to prevent damage from short circuit.
3. Check the CPU FAN connector is connected to the motherboard.
4. For Intel platforms check the pins on the CPU socket for damage or bent. A bent pin may cause failure to boot and sometimes permanent damage from short circuit.
5. Check the 12V power connector is connected to the motherboard.
6. Check that the 12V power & ATX connectors are fully inserted into the motherboard connectors. Make sure the latches of the cable and connector are locked into place.

#### ***b) Power is on, fans are running but there is no display***

1. Make sure the monitor is turned on and the monitor cable is properly connected to the PC.
2. Check the VGA adapter card (if applicable) is inserted properly.
3. Listen for beep sounds. If you are using internal PC speaker make sure it is connected.
  - a. continuous 3 short beeps: memory not detected
  - b. 1 long beep and 8 short beeps: VGA not detected

#### ***c) The PC suddenly shuts down while booting up.***

1. The CPU may experience overheating so it will shutdown to protect itself. Apply the thermal grease onto the CPU heatsink & ensure the CPU fan is well-connected with the CPU heatsink. Check if the CPU fan is working properly while the system is running.

2. From the BIOS setting, try to disable the Smartfan function to let the fan run at default speed. Doing a Load Optimised Default will also disable the Smartfan.

## Start up problems after prolong use

After a prolong period of use your PC may experience start up problems again. This may be caused by breakdown of devices connected to the motherboard such as HDD, CPU fan, etc. The following tips may help to revive the PC or identify the cause of failure.

1. Clear the CMOS values using the CLR\_CMOS jumper. Refer to CLR\_CMOS jumper in Chapter 2 for Checking Jumper Settings in this user manual. When completed, follow up with a Load Optimised Default in the BIOS setup.
2. Check the CPU cooler fan for dust. Long term accumulation of dust will reduce its effectiveness to cool the processor. Clean the cooler or replace a new one if necessary.
3. Check that the 12V power & ATX connectors are fully inserted into the motherboard connectors. Make sure the latches of the cable and connector are locked into place.
4. Remove the hard drive, optical drive or DDR memory to determine which of these components may be at fault.
5. Check whether there is any bulked up electrolytic capacitor or abnormal component.

Please log onto our ECS website: [http://www.ecs.com.tw/ECSWebSite/Support/Technical\\_Support\\_List.aspx?MenuID=50&LanID=0](http://www.ecs.com.tw/ECSWebSite/Support/Technical_Support_List.aspx?MenuID=50&LanID=0) for more information.

## Maintenance and care tips

Your computer, like any electrical appliance, requires proper care and maintenance. Here are some basic PC care tips to help prolong the life of the motherboard and keep it running as best as it can.

1. Keep your computer in a well ventilated area. Leave some space between the PC and the wall for sufficient airflow.
2. Keep your computer in a cool dry place. Avoid dusty areas, direct sunlight and areas of high moisture content.
3. Routinely clean the CPU cooler fan to remove dust and hair.
4. In places of hot and humid weather you should turn on your computer once every other week to circulate the air and prevent damage from humidity.
5. Add more memory to your computer if possible. This not only speeds up the system but also reduces the loading of your hard drive to prolong its life span.
6. If possible, ensure the power cord has an earth ground pin directly from the wall outlet. This will reduce voltage fluctuation that may damage sensitive devices.





**Memo**